

BOLANG
PROFESSIONAL OPTICAL ENDOSCOPE

**UROLOGY OF
TIANJIN BOLANG**

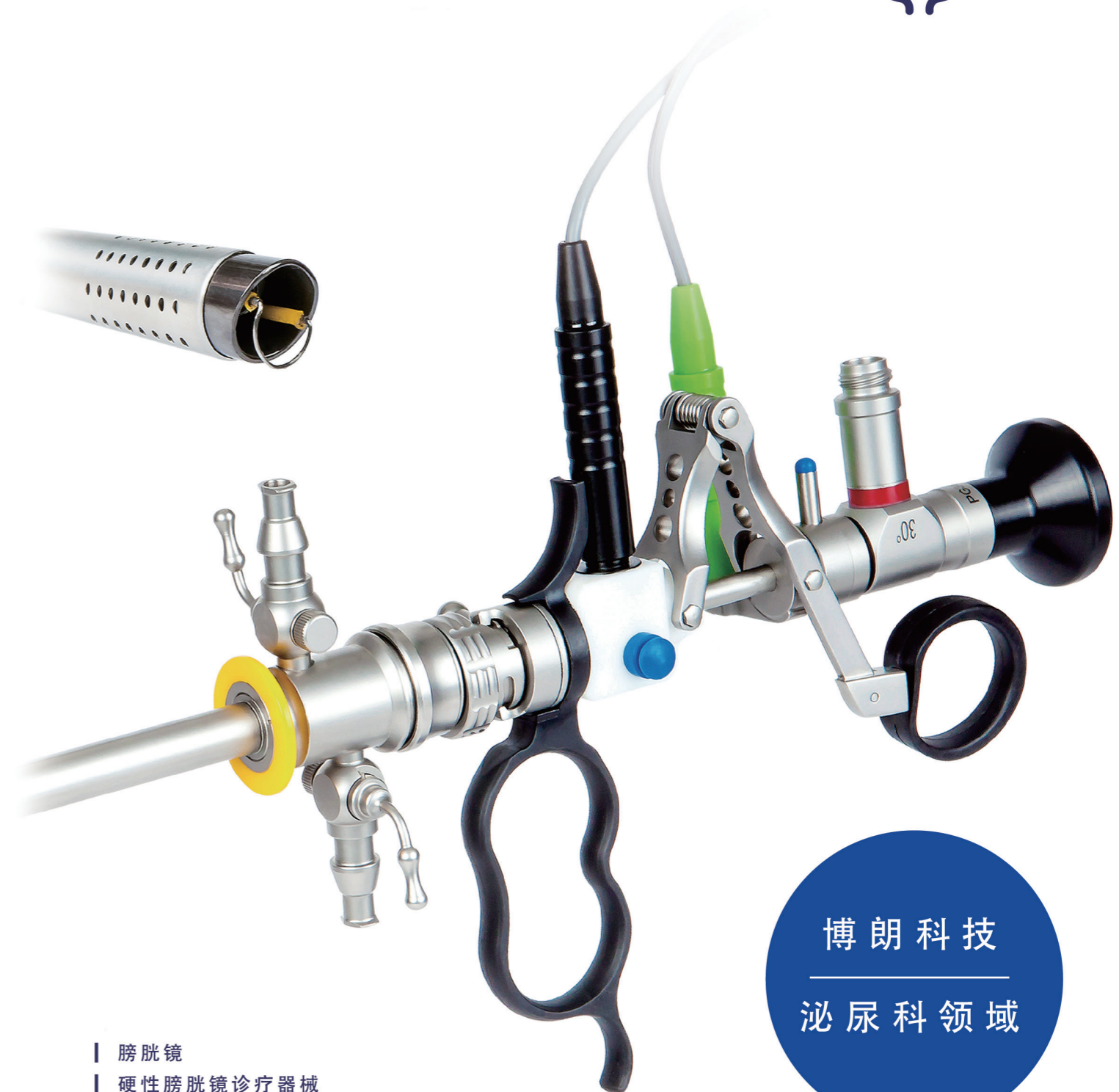

博朗科技
泌尿科领域

BOLANG
PROFESSIONAL OPTICAL ENDOSCOPE

天津博朗科技发展有限公司

地址：天津华苑产业区海泰绿色产业基地二纬路六号D座401

邮编：300384

电话：+86-22-23788271

传真：+86-22-23788271

邮箱：info@bolangendo.com

网站：www.bolangendo.com

Tianjin Bolang Science Technology Development Co.,Ltd

Add: Rm401, Block D, Hi-tech Green Industrial Base, Xiqing District

300384 Tianjin China

Tel: +86-22-23787098

Fax: +86-22-23788271

Email: info@bolangendo.com

Web: www.bolangendo.com

- | 膀胱镜
- | 硬性膀胱镜诊疗器械
- | 泌尿科相关器械



UROLOGY OF TIANJIN BOLANG

BOLANG
PROFESSIONAL OPTICAL ENDOSCOPE

**TECHNOLOGY
CREATES
THE FUTURE**

细节决定品质 科技铸就未来

结合临床，了解医生所需，最大程度的减轻病人痛苦，达到客户的满意，是博朗公司一贯的宗旨。优化的设计，可靠的安全性以及方便的操作性，已成为我公司产品的显著特点，并已得到业内专家的普遍认可。

Combined with the clinical testing, understand the doctor's requests, minimize the pains of the patients, achieve all the customers' satisfaction, which are the aims of the bolang company. Optimization design, reliable safety and convenient operation, have become the significant characteristics of the Tianjin Bolang Science-Technology Development Co., Ltd. products, which has set up a general recognition in the industry experts.

Welcome to Urology of Tianjin Bolang

欢迎进入博朗科技泌尿科领域

随着泌尿科内窥镜影像技术突飞猛进的发展，天津博朗科技发展有限公司始终保持不断地完善影像系统，提高器械发展质量。确保产品品质，工艺，设计精益求精，使得博朗内镜系统在泌尿外科诊断及内镜治疗领域里成为最可信赖的设备！

With the rapid development of urological endoscope imaging technology, Tianjin Bolang science Technology Development Co., Ltd. has been improving the image system, developing the quality of instrument constantly. Keep Improving of product quality, technology and design, Bolang endoscope is the most reliable instrument in the field of diagnosis and endoscopic therapy.

泌尿科目录

Table of Content:

膀胱镜

Cystoscope:

2.7/2.9/3.0/4.0mm 硬性膀胱镜 2.7/2.9/3.0/4.0mm Cystoscope

膀胱镜诊疗器械

Cystoscope Instrument:

膀胱尿道镜鞘	Cysto-Urethroscope Sheath
手术器械	Operating Instrument
抬起器（导管转向器）	Catheter Deflecting Mechanism
连接镜桥	Telescope Bridge
电切镜	Resectoscope
激光电切镜	Laser Resectoscope
Z型膀胱镜	Z Type Cystoscope
经皮肾镜	Percutaneous Nephroscope
可视尿道切开镜	Visible Urethrotome
拉式碎石钳	Lithoclast
大力碎石钳	Lithotripsy
造瘘器	Fistular
冲洗器	Evacuator

泌尿科相关设备

Related Devices:

摄像机	Camera
光源	Light Source
光缆	Light Cable
气腹机	Insufflator

Cystoscope
膀胱镜

Cystoscope
Instrument

膀胱镜及诊疗器械

Cystoscope
膀胱镜

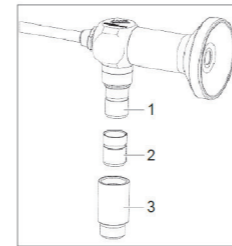

CONNECTION WITH ILLUMINATION FIBER

可通配光缆

- 1.Type ACMI
- 2.Adapter type WOLF
- 3.Adapter type Storz/Olympus



ITEM NO	DIAMETER	WORKING LENGTH	DIRECTION OF VIEW	GRADE	TO SYSTEM
序列号	直径	工作长度	视向角	等级	适用系统
PG40300	4.0mm	301mm	0°	SD/WA	Storz/ Wolf/ Olympus
PG40312	4.0mm	301mm	12°	SD	
PG40325	4.0mm	301mm	25°	SD	
PG40330	4.0mm	301mm	30°	SD/WA	
PG40370	4.0mm	301mm	70°	SD/WA	
PG30300	3.0mm	301mm	0°	SD/WA	
PG30312	3.0mm	301mm	12°	SD	
PG30330	3.0mm	301mm	30°	SD/WA	
PG30370	3.0mm	301mm	70°	SD	
PG29300	2.9mm	301mm	0°	SD/WA	
PG29312	2.9mm	301mm	12°	SD	
PG29330	2.9mm	301mm	30°	SD/WA	
PG29370	2.9mm	301mm	70°	SD	
PG27300	2.7mm	301mm	0°	SD/WA	
PG27312	2.7mm	301mm	12°	SD	
PG27325	2.7mm	301mm	25°	SD	
PG27330	2.7mm	301mm	30°	SD/WA	
PG30100	3.0mm	190mm	0°	SD/WA	
PG30130	3.0mm	190mm	30°	SD/WA	
PG29100	2.9mm	190mm	0°	SD/WA	
PG29130	2.9mm	190mm	30°	SD/WA	
PG27100	2.7mm	190mm	0°	SD/WA	
PG27130	2.7mm	190mm	30°	SD/WA	

★等级 SD¹: 标清 Standard / WA²: 广角 Wide Angle

Cysto-Urethroscope Sheath

膀胱尿道镜鞘

此套器械包含
Consisting of

- 可操作检查鞘
- 冲洗阀门
- 闭孔器
- Operative-examination Sheath
- Irrigation valve
- Obturator

带有两个用于
持续对流的
固定旋阀及钝头闭孔器

Cysto-Urethrosopic sheath with two stationary rotary valves for continuous convection and a blunt obturator



21FR
WORKING CHANNEL

ITEM NO	FOR ENDOSCOPE Ø/LENGTH	WORKING CHANNEL/FR
序列号	适用内镜直径及工作长度	工作通道
MN.PGJQ.17	4mm / 230mm	17Fr
MN.PGJQ.19	4mm / 230mm	19Fr
MN.PGJQ.198	4mm / 230mm	19.8Fr
MN.PGJQ.21	4mm / 230mm	21Fr
MN.PGJQ.22	4mm / 230mm	22Fr
MN.PGJQ.23	4mm / 230mm	23Fr
MN.PGJQ.25	4mm / 230mm	25Fr



17FR
WORKING CHANNEL

19.8FR
WORKING CHANNEL

22.5FR
WORKING CHANNEL

INSTRUMENT 手术器械



序列号 ITEM NO	产品 PRODUCT	尺寸 SIZE
软钳 FLEXIBLE FORCEPS		
MN.5FF36A / MN.7FF36A	活检钳 Biopsy Forceps	5Fr/7Fr*360mm
MN.5FF36B / MN.7FF36B	异物钳 Foreign Body Forceps	5Fr/7Fr*360mm
MN.5FF36C / MN.7FF36C	剪刀 Scissors	5Fr/7Fr*360mm
MN.5FF36D / MN.7FF36D	抓取钳 Grasper Forceps	5Fr/7Fr*360mm



活检钳 (输尿管)
Biopsy Forceps

异物钳 (输尿管)
Foreign body Forceps

序列号 ITEM NO	产品 PRODUCT	尺寸 SIZE
硬钳 FLEXIBLE FORCEPS		
MN.5RF56A	活检钳 Biopsy Forceps	5Fr*560mm
MN.5RF56B	异物钳 Foreign Body Forceps	5Fr*560mm

Catheter Deflecting Mechanism

抬起器 (导管转向器)

带有
ALBARARRAN
调节杆的工作插件，
带光栅和器械通道

With ALBARRAN lever,
raster and
instrument channel

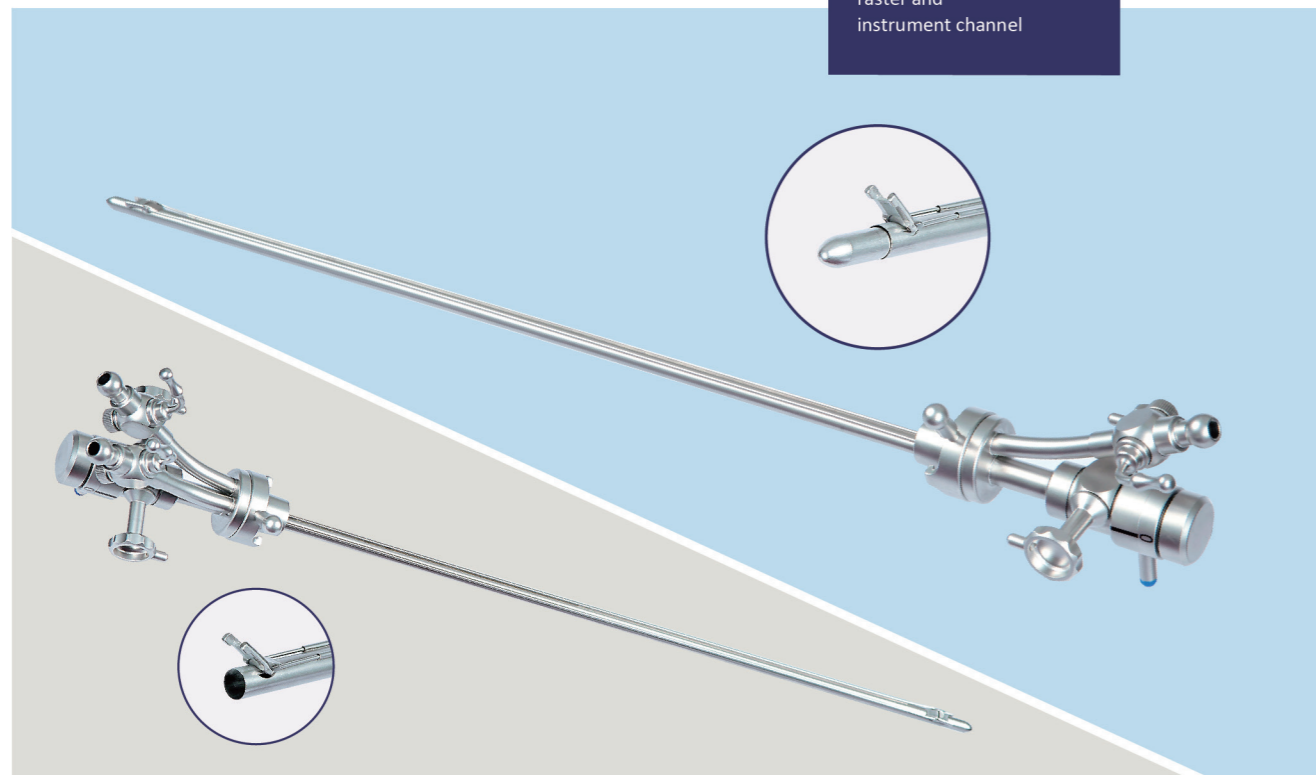

ITEM NO 系列号	PRODUCT 产品	COMPATIBLE WITH SHEATH/ FR 匹配膀胱镜鞘尺寸	WORKING CHANNEL/FR. 器械通道尺寸
MN.TQQ.D	单器械通道 Single Instrument Channel	19.8Fr	5Fr 7Fr
		21Fr	
		22Fr	
		23Fr	
		25Fr	
MN.TQQ.S	双器械通道 带有弯折保护 Double Instrument Channels, with bend protection	19.8Fr	2 x 5 Fr 2 x 7 Fr
		21Fr	
		22Fr	
		23Fr	
		25Fr	

治疗用的检查插件，
配有器械通道，与膀胱尿道镜鞘配合使用

Telescope Bridge with instrument channel, use with
Cysto-Urethroscope Sheath

连接镜桥 Telescope bridge

ITEM NO 系列号	PRODUCT 产品	COMPATIBLE WITH SHEATH/ FR 匹配膀胱镜鞘尺寸	WORKING CHANNEL/FR 器械通道尺寸
MN.DQ	连接镜桥 - 单器械通道 Telescope Bridge- Single Instrument Channel	17Fr	5Fr 7Fr
		19.8Fr	
		21Fr	
		22Fr	
		23Fr	
MN.SQ	连接镜桥 - 双器械通道 Telescope Bridge- Double Instrument Channels	17Fr	2 x 5 Fr 2 x 7 Fr
		19.8Fr	
		21Fr	
		22Fr	
		23Fr	
		25Fr	

连接镜桥 - 单器械通道
Telescope Bridge-Single Instrument Channel



ITEM NO MN.DQ

连接镜桥 - 双器械通道
Telescope Bridge-Double Instrument Channels



ITEM NO MN.SQ

Resectoscope

手术内窥镜（汽化电切镜）

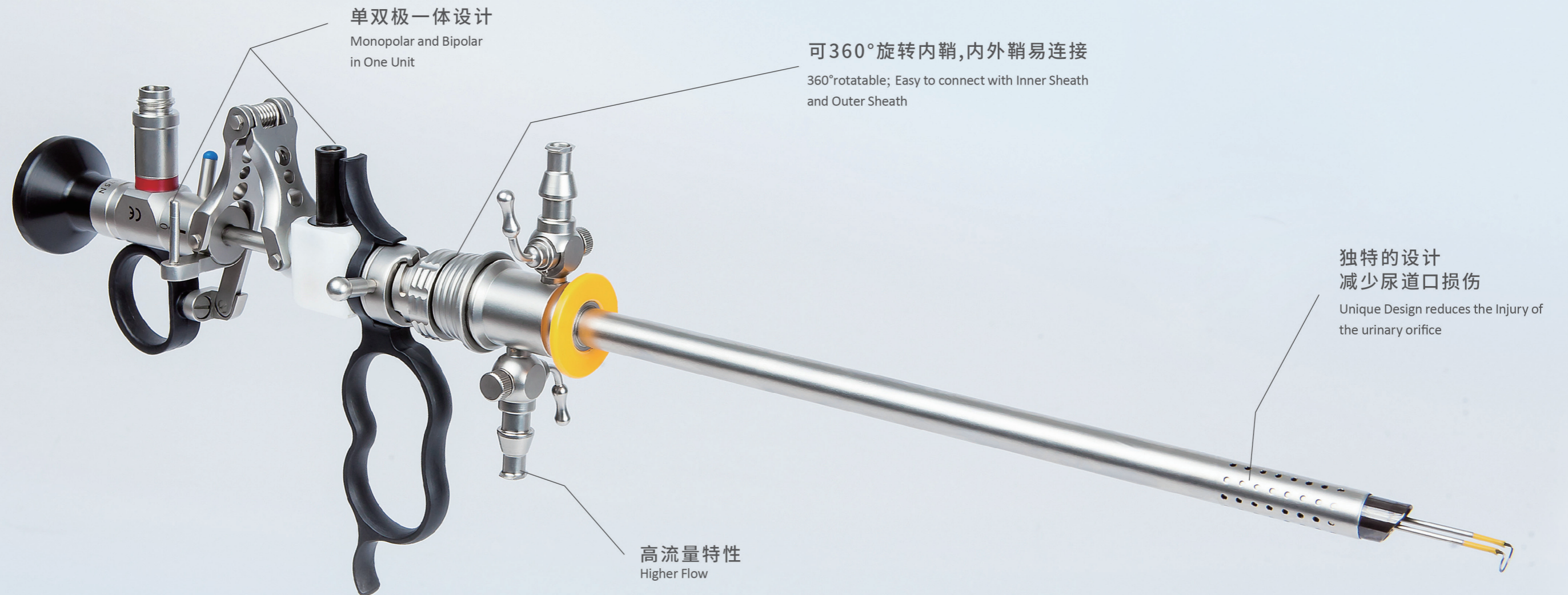

相较于传统电切镜设计相比, 博朗电切镜设计既为患者降低了损伤风险, 又方便了医生的使用。

Compared with the traditional design, BOLANG resectoscope not only can reduce the risk of injury, also can provide convenience for doctors.

电切镜工作操作器 Resectoscope Working Element

PRODUCT 产 品	WORKING ELEMENT 工作操作器				
	MONOPOLAR&BIPOLAR ONE UNIT 单双极一体操作器		BIPOLAR WORKING ELEMENT 双极操作器		
	COMPATIBLE WITH STORZ 与 STORZ 电切镜相匹配		COMPATIBLE WITH GYRUS 与佳乐电切镜相匹配		COMPATIBLE WITH STORZ AND GYRUS 适配STORZ与佳乐电切镜
	ACTIVE 主动式	PASSIVE 被动式	ACTIVE 主动式	PASSIVE 被动式	PASSIVE 被动式
REFERENCE PICTURE 参考图片					
ITEM NO. 编 号	DQ.111.244 DQ.111.344	DQ.111.242 DQ.111.342	DQ.121.244 DQ.121.344	DQ.121.242 DQ.121.342	DQ.121.000

持续灌流的外鞘，内鞘及标准闭孔器 Continuous-flow operative sheath, inner sheath and standard obturator



ITEM NO	PRODUCT	SPECIFICATION	REFERENCE PICTURE
系列号	产 品	规 格	参 考 图 片
DQ.NQ	Inner Sheath 内 鞘	20Fr/21Fr/24Fr/25Fr	
DQ.WQ	Outer Sheath 外 鞘	23Fr/24Fr/26Fr/27Fr	
DQ.BKQ.BZ	Standard Obturator 标准闭孔器		
DQ.BKQ.DX	Deflecting Obturator 导向闭孔器		
DQ.KSBKQ.QX	Visible Obturator 可视闭孔器	With Working Channel 带有器械通道	

ITEM NO	PRODUCT	SPECIFICATION	REFERENCE PICTURE
系列号	产 品	规 格	参 考 图 片
DQ.NQS	Rotatable Irrigation Adapter - with luer connector and stopcock 内鞘适配器	When the urethra of patient is small, Inner Sheath Adapter could be: Instead of outer sheath, connect with the inner sheath directly 当病人尿道狭窄时,可使用内鞘适配器直接与内鞘连接	
PJ.JT	Water Flow Connector 水接阀	Luer-Lock Connector, with stopcock 鲁尔接头, 带控制阀门	

Loop 电极环

ITEM NO.	LOOP
序列号	电 切 环
DQH.D.P	带状电极 Strip electrode
DQH.D.T	环状电极 Loop electrode
DQH.S.P	辊状电极 Roller electrode
DQH.S.T	滚珠电极 Rollerball electrode
DQH.JL	刀状电极 Knife electrode



Laser Resectoscope

激光电切镜

为探寻患者的理想治疗方案时，由于最新激光技术的引入，诞生了一种新的温和有效的前列腺切除标准手术方式。如今，激光电切镜的应用已成为一种传统高频电切手术的极佳替代方案。通过光纤，从激光发生器传输到操作器的尖端，可准确操控切割前列腺组织。

In order to explore the ideal treatment for patients, a new mild and effective standard procedure for prostatectomy has been developed due to the introduction of the latest laser technique. Today, the application of laser resectoscope has become an excellent alternative to traditional high-frequency electrotomy. Through the optical fiber, from the laser generator to the tip of the laser resectoscope, accurate control of the cutting of prostate tissue.

博朗激光电切镜可360°旋转，持续灌流设计，准确安全的引导光纤探头，内鞘可通用连接激光电切手件和高频电切手件，使医生操作更加便利精准，大大降低手术风险。

BOLANG laser resectoscope, can be 360° rotated, continuous perfusion design, with accurate and safe guide fiber probe. The inner sheath can be connected with laser resectoscope working element or high-frequency resectoscope's, so that doctors not only operate more conveniently and accurately, but also reduce the risk of operation greatly.

博朗激光电切镜 手件具有以下特点

Characteristics of Bolang Laser
Resectoscope Working Element:

- 光纤入口外型设计，易插入光纤
- 独特的光纤锁紧装置有效避免了光纤机械损伤，弯折与破损
- 为了达到光纤最大限度的稳定性，此操作器可配有不同内径的光纤适配管
- 防水装置解决了因医生误操作进出水阀门对光纤的机械损坏问题
- 可旋转的持续灌流设计，有效防止损伤尿道

- Easy to insert fiber
- Unique fiber optic locking device avoids mechanical damage, bending and breakage of fiber optics effectively.
- In order to achieve maximum stability of the fiber, this operator can be equipped with fiber adapter tubes in different inner diameters.
- The waterproof device solves the problem of mechanical damage to the optical fiber, which caused by the doctor's misoperation of the valve.
- Rotatable continuous perfusion design to prevent injury to the urethra effectively.

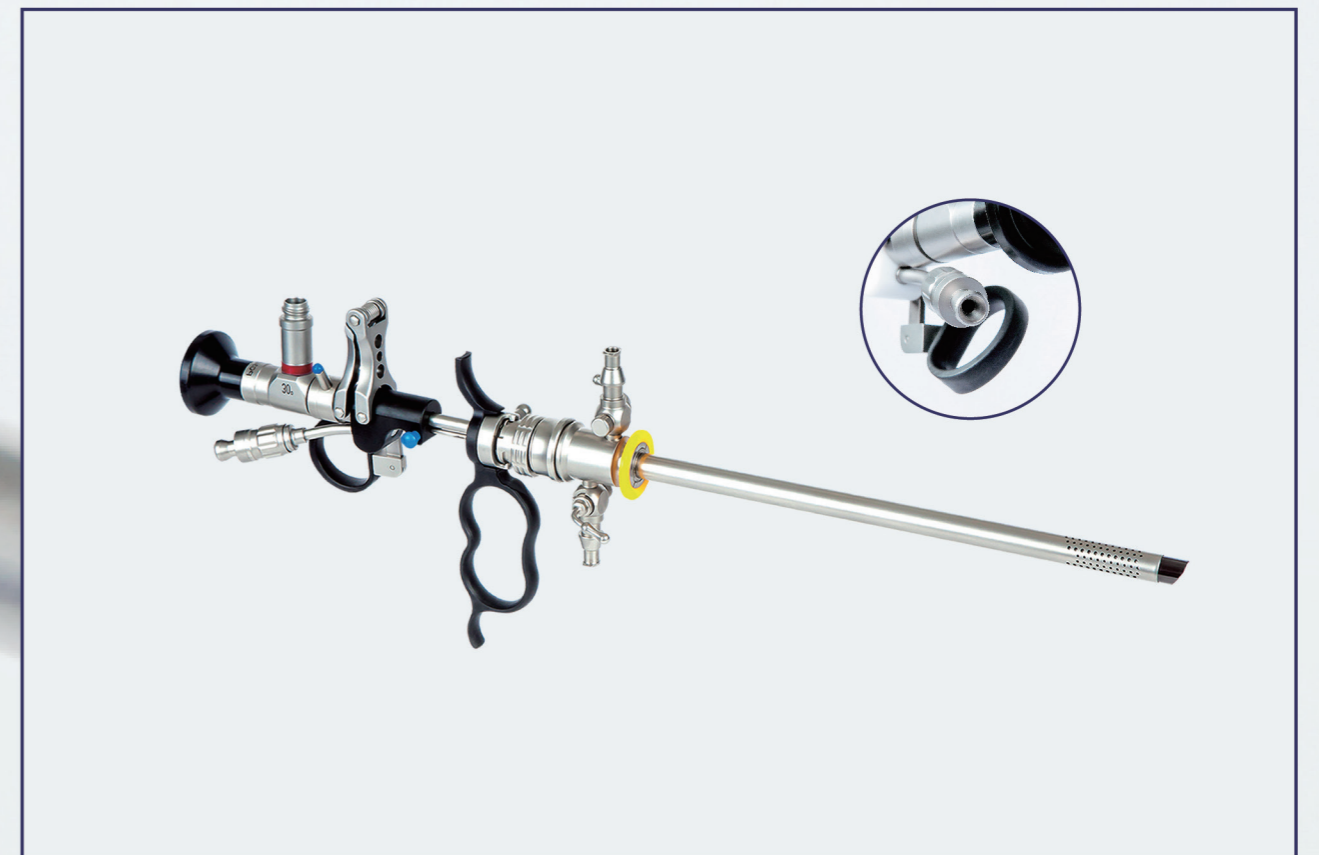

ITEM NO	PRODUCT	SPECIFICATION
序列号	产品	规格
DQ.SJG	激光电切镜手件 Laser Resectoscope Working Element	
DQ.BKQ.BZ	闭孔器 Obturator	
DQ.NQ24	内鞘 Inner Sheath	20Fr/21Fr/24Fr/25Fr
DQ.WQ26	外鞘 Outer Sheath	23Fr/24Fr/26Fr/27Fr
PG.040.030.3020.1	膀胱镜 Cystoscope	4.0mm/ 30°
DQ.GXG	光纤适配管 Fiber Adapter	1.0mm/1.2mm/1.4mm/1.6mm/1.8mm

Z Type Cystoscope

Z 型膀胱镜

可通过平行目镜的内镜的直形工作通道引入器械

to guide the instrument with a straight working channel through the telescope's parallel eyepiece

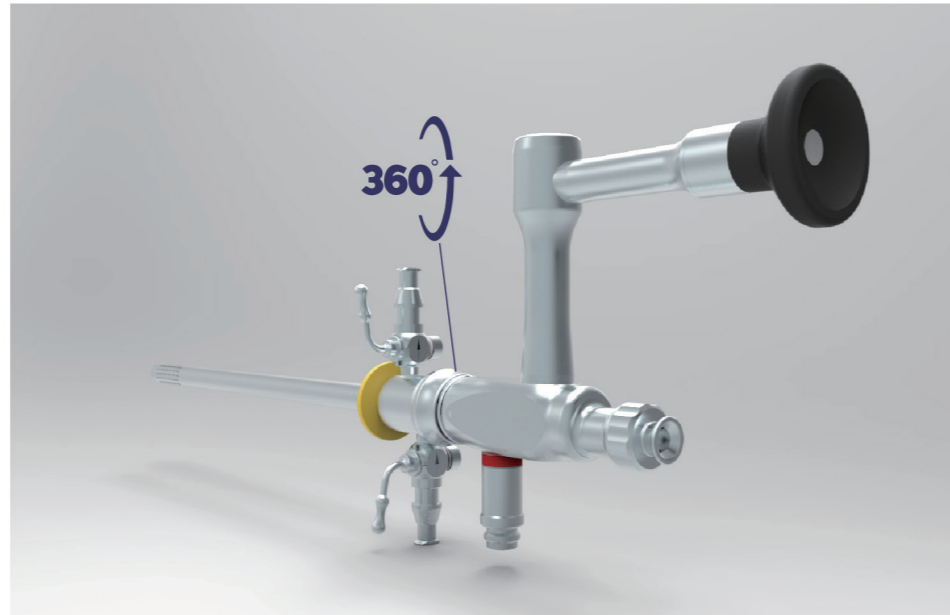

- 超高清视野为医生提供良好的视觉效果
- 独特的结构设计有效防止机械损伤, 避免误操作
- 镜鞘的通用性为医生提高手术效率

- Ultra HD vision provides excellent image quality for doctors
- Unique structural design prevent mechanical damage and avoid misoperation effectively
- Universal outer sheath can effectively improve the quality and efficiency of surgery

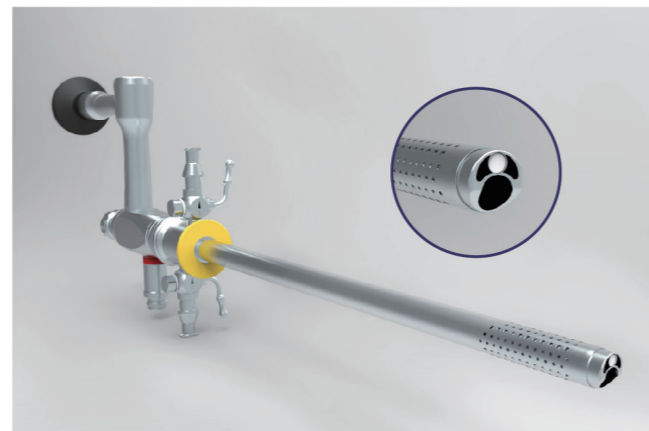

ITEM NO	OUTER TUBE SIZE/FR	APPLICATIVE ENDOSCOPE	WORKING LENGTH/MM	WORKING CHANNEL/FR.
序列号	外部尺寸	适用的内窥镜	工作长度	工作通道
ZJPG261420	9mm(26Fr)	0°/12°/20°/25°/30° SD/WA	185	4.9

Percutaneous Nephroscope

经皮肾镜

- 持续灌流, 高流量特性
- 超清晰画质, 提供广角视野
- 独特的器械通道设计避免因误操作导致漏水失误
- 博朗系列产品的通用性外鞘, 节约手术时间, 大大提高手术安全性

- Continuous irrigation and suction, High flow;
- Excellent image quality, wide angle;
- Unique design of instrument channel avoid leakage due to improper operation;
- Universal outer sheath is compatible with other BOLANG products, saving surgery time to improve surgical safety effectively

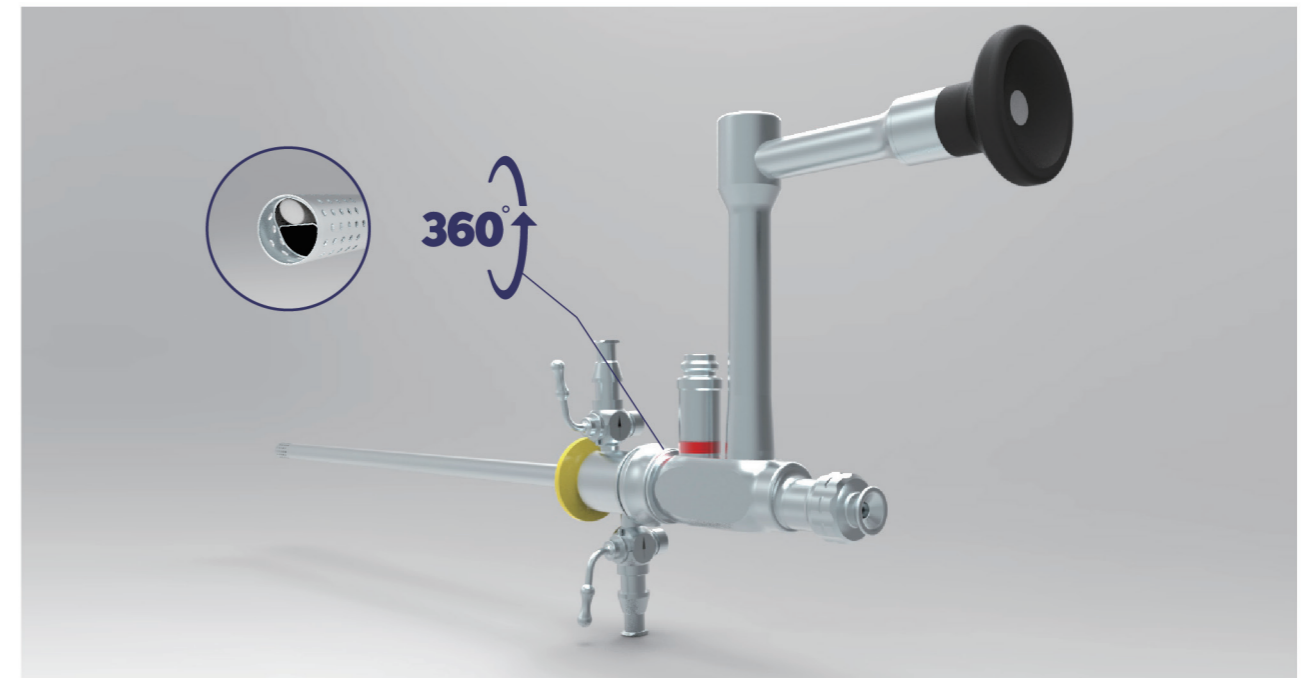
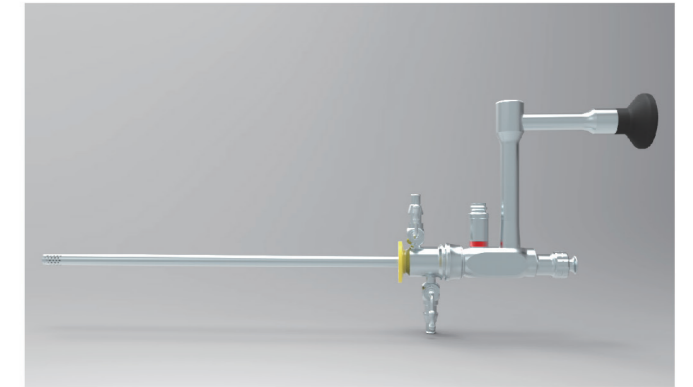

ITEM NO	OUTER TUBE SIZE/FR	APPLICATIVE ENDOSCOPE	WORKING LENGTH/MM	WORKING CHANNEL/FR.
序列号	外部尺寸	适用的内窥镜	工作长度	工作通道
JPS1.7215	7mm (21Fr)	0°/12°/20°/25°/30° SD/WA	215	3.3



PROFESSIONAL
OPTICAL
ENDOSCOPE



可配有中空闭孔器，
通道尺寸为5Fr

Option: Hollow
Obturator, with Fr5
channel

Visible Urethrotome 可视尿道切开镜

ITEM NO	PRODUCT	SPECIFICATION
序列号	产 品	规 格
DQ.NDQKJ.SJ	可视尿道切开镜手件 Visual Urethrotome Working Element	带冷刀导管 With Cold Knife Catheter
DQ.BKQ.BZ	闭孔器 Obturator	标准闭孔器 Standard
DQ.BKQ.ZK	闭孔器 Obturator	中空闭孔器 Hollow
MN.NDQKJ.Q	尿道刀鞘 Urethrotome Sheath, with Supplementary Sheath	有刻度, 带倾斜器械通道, 工作通道为5Fr Calibrated, with tilted instrument channel, working channel 5Fr
PG.40330	膀胱镜 Cystoscope	ø4mm 30°
MN.NDQKJ.A	冷刀 Cold Knife	圆形刀头 Round
MN.NDQKJ.B	冷刀 Cold Knife	直刀, 波浪形切口 Straight, Lancet
MN.NDQKJ.C	冷刀 Cold Knife	倒钩形刀头 Hook
MN.NDQKJ.D	冷刀 Cold Knife	半圆形刀头 Semicircle

Lithoclast 拉式碎石钳

较大的结石
可以被拉式碎石钳压成
能被吸走的小颗粒。

Large stones will be made into smaller particles which can be sucked easily by using this pull-type lithotrite.

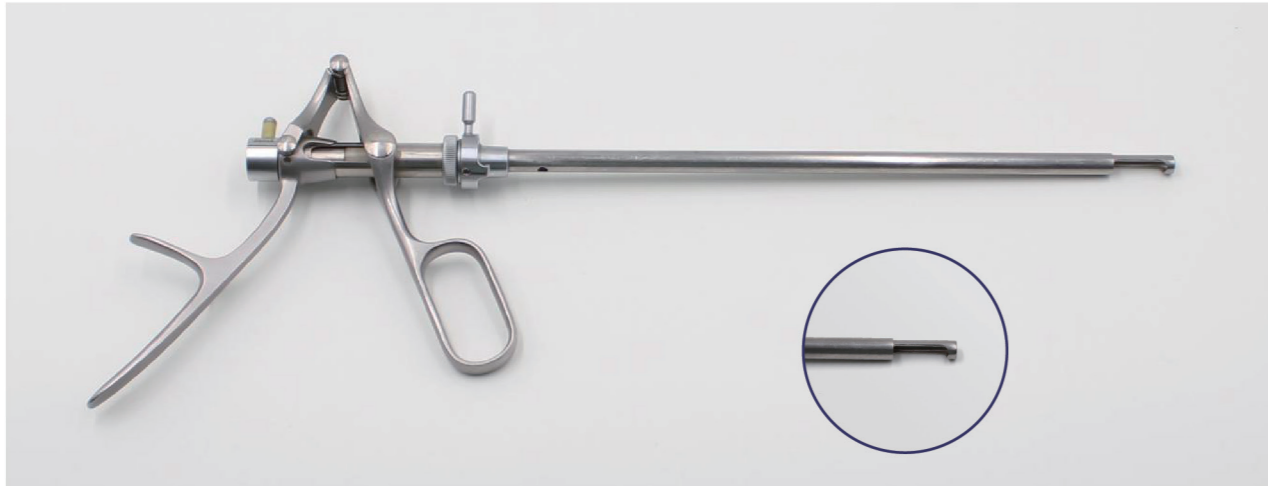

ITEM NO	PRODUCT	SPECIFICATION
序列号	产 品	规 格
MN.LSSSQ	拉式碎石钳 / Lithoclast	21Fr/24Fr
MN.DLSSQ	大力碎石钳 / Lithotripsy	23.7Fr

Fistular 造瘻器

Lithotripsy 大力碎石钳

高强度的钳口
允许通过螺栓机制加大力度，
使用手柄可快速碾碎结石。

High strength forceps jaws increases the speed of the bladder lithotripsy with the handle through the stronger bolt mechanism.

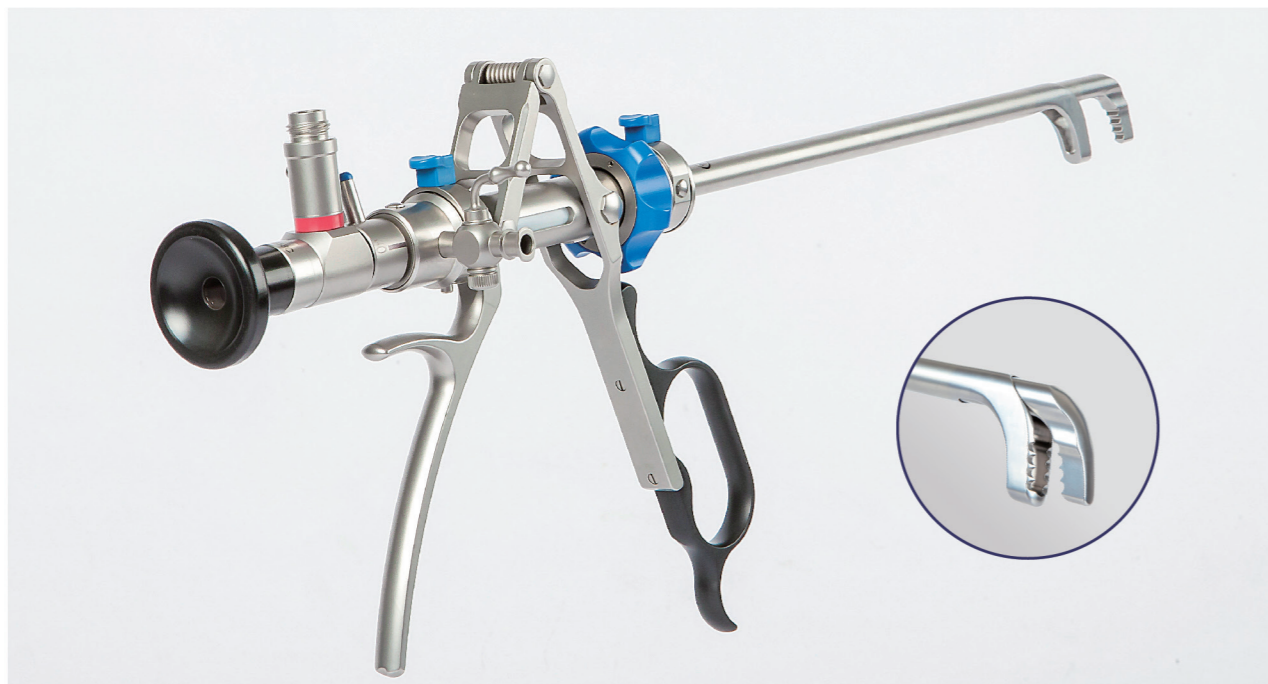

ITEM NO	PRODUCT	SPECIFICATION
序列号	产 品	规 格
MN.CCZLQ18	造瘻器 / Fistular	18Fr
MN.CCZLQ20	造瘻器 / Fistular	20Fr
MN.CCZLQ22	造瘻器 / Fistular	22Fr

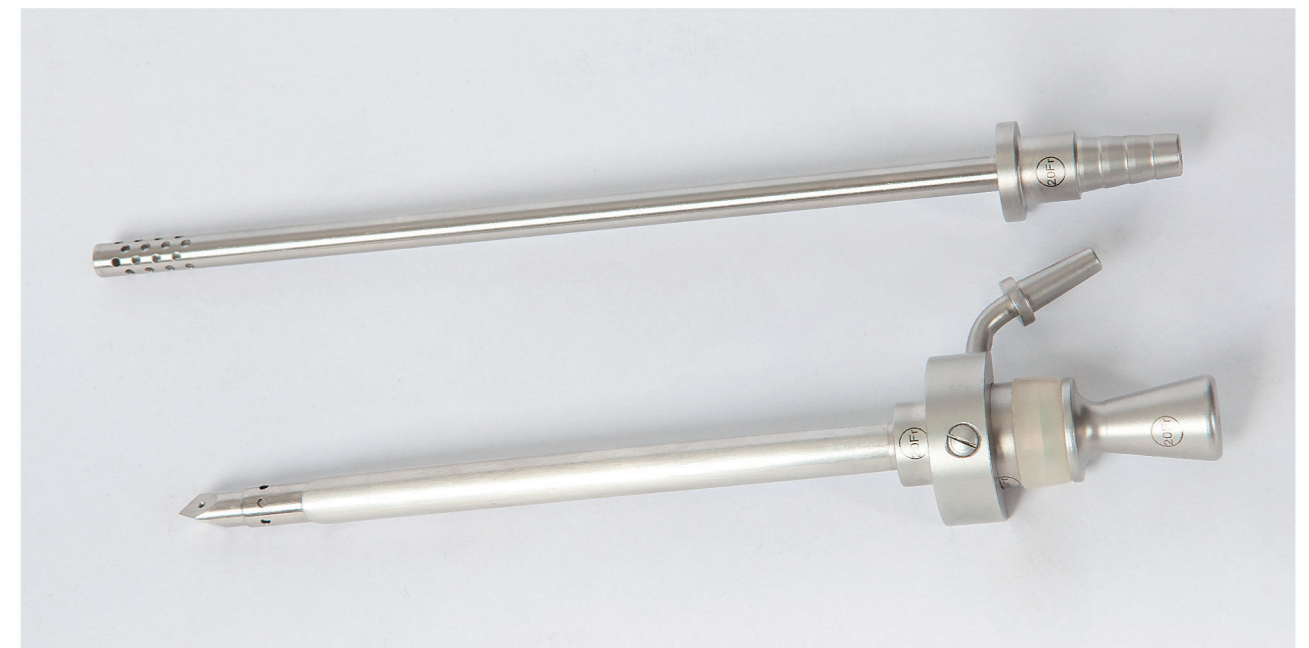

Evacuator 冲吸器

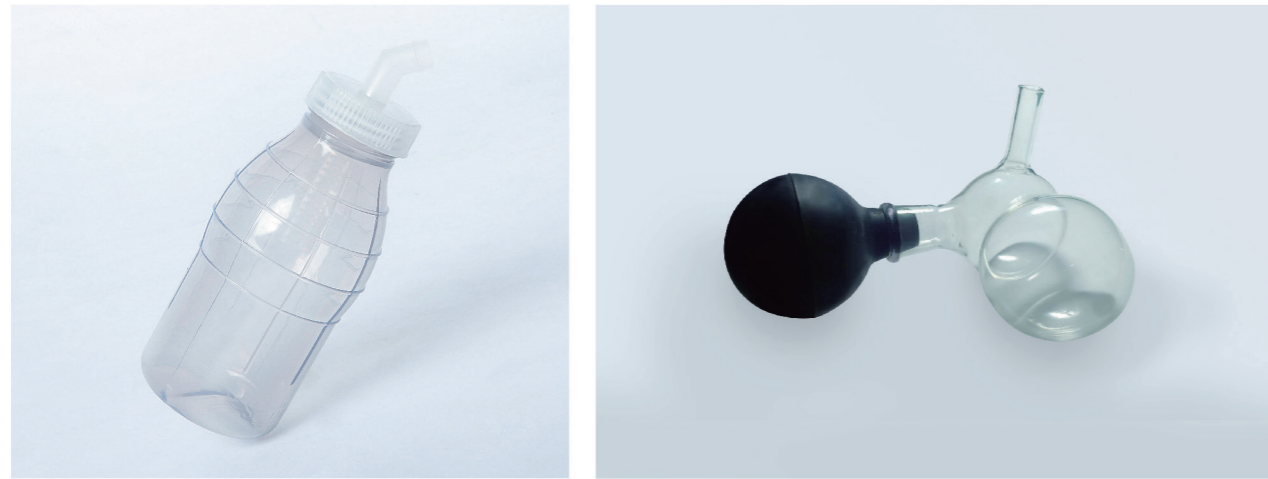

ITEM NO	PRODUCT
序列号	产 品
MN.CXQA	冲吸器 (艾力克) Evacuator / Alic
MN.CXQH	冲吸器 (霍夫曼) Evacuator / Hoffman

Adaptor of Evacuator 冲吸器接头



ITEM NO	PRODUCT	TO SYSTEM
序列号	产 品	使用系统
MN.CXQA.S	Adaptor with Tube 冲吸器接头 (带皮管)	Storz
MN.CXQA.W		Wolf
MN.CXQA.O		Olympus

BOLANG
PROFESSIONAL OPTICAL ENDOSCOPE

Related Devices 相关电气设备

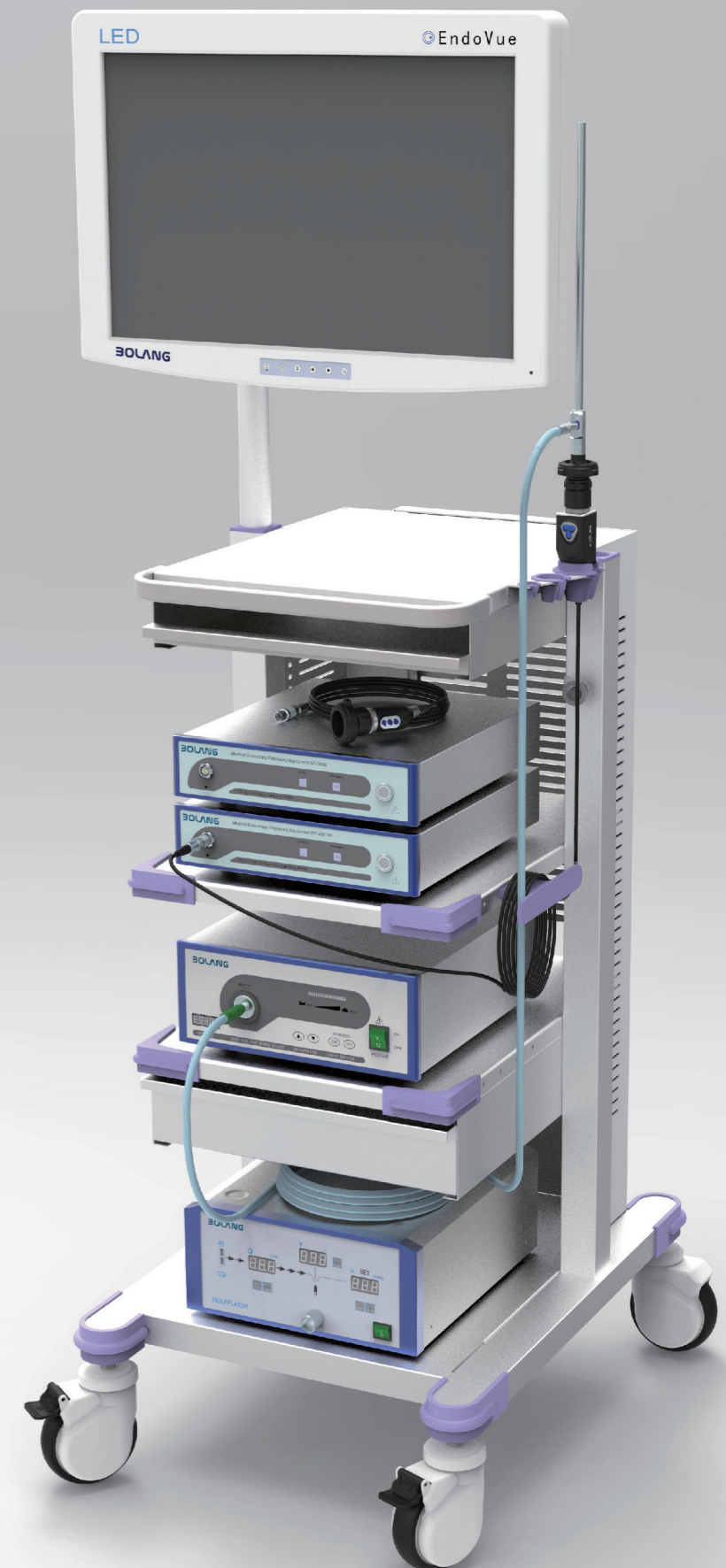

Related Devices
泌尿科相关设备

Image System
显像系统

Camera 摄像机

NT-300HD是最新版本高清内窥镜摄像机,它能输出最清晰的画质。高分辨率且带有逐行扫描功能,可提供最清晰的细节和无与伦比的自然色彩,即使在组织中最细微的变化都可清晰分辨出来,尽可能的辅助医生提高执行微创手术的能力。

★
此外,天津博朗还提供其他配置摄像机,详情请参阅电气设备彩页。

NT-300HD, is the latest version of in the HD endoscope cameras, delivers the clearest image quality. High resolution and progressing scan features provide the clearest detail and unparalleled natural color, even the smallest changes in the tissue can be clearly identified, as much as possible to assist the doctor to improve the ability to perform minimally invasive surgery.

Additionally, Tianjin Bolang company also provides other configuration cameras. For details, please refer to the electrical equipment catalog.



摄像头光学适配器
Camera Optic Coupler



摄像头定焦适配器
Camera Optic Coupler
with fixed - focus, F18,
F20, F22, F25, F28, F32, F35



摄像头变焦适配器
Camera Optic Coupler
with zoom, F15-F25,
F18-F35

型号Model	NT-300HD
输出像素 Output pixels	1920 (H) x 1080 (V)
影像传感器 Image sensor	1/3 Inch
使用预设置 Working modes (User settings)	5 users or modes
输出 Digital Video output	2 x 3G-SDI / HD-SDI (OPTIONAL) 2 x DVI on DVI-D Connector
电压 Main voltage V	100 - 120 / 200 - 240
频率 Main frequency Hz	50/60
摄像头等级 Classification of camera head	BF
摄像头尺寸 Dimensions of camera head	34 × 42 × 58 mm
适配器接口 Interface for connecting adapter (Lens)	C型接口Standard C mount
缆线长度 Length of camera cable	3 m
重量 Weight (without camera cable and plug)	130 g
摄像机尺寸 Dimension	325 × 74 × 365 mm
摄像机重量 Weight	5.1 kg

LED Light Source LED 冷光源

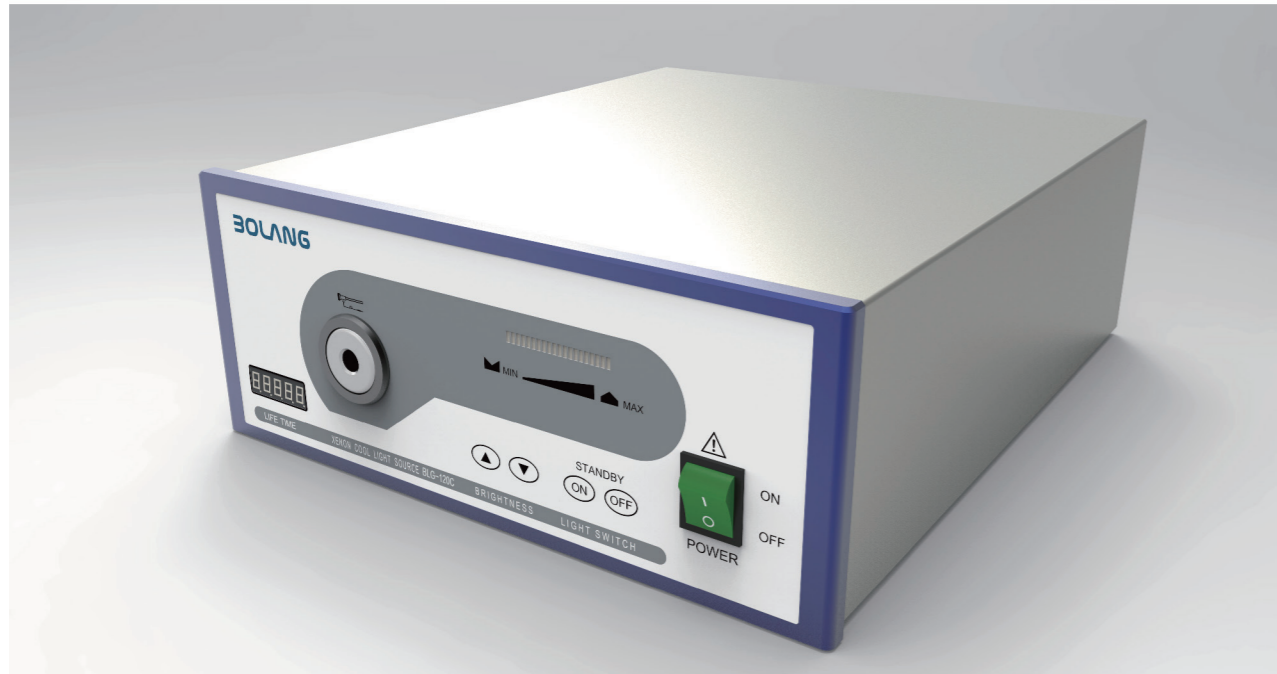

博朗LED光源具有极高的效率和寿命或使用时间。替代150瓦和250瓦卤素灯，超常的使用寿命或使用时间（大于50000小时）使LED光源成为最具成本效益的照明装置，实际中不再需要更换灯泡。

工作模式下这款机器几乎没有任何噪音，光源产生噪音不超过30dB,比传统光源安静四倍，为医生手术带来舒适的操作环境，减少干扰。

Bolang LED light source has high efficiency and long lifetime. Instead of 150-watt and 250-watt halogen light Source, the exceptional lifetime (more than 50000 hours) makes the LED light source become the most cost-effective lighting device and virtually no longer needs to be replaced.

In working mode, the machine has almost no sound. The noise generated by the light source is no more than 30 dB, which is four times quieter than the traditional light source needs to change the lamps. It provides a comfortable operating environment for doctors and reduces interference.

- 照明亮度堪比250瓦卤素灯
- 超长工作时间，减少因灯泡等原因造成的突发情况
- 工作声音极低，噪音不超过30dB
- 色温不会因光亮的减弱或LED灯泡老化而改变，始终保持如一的视物视像

- Illumination is as bright as 250 watt halogen lamps.
- Unparalleled long life time , reduce contingencies caused by light bulbs
- Super Silent, Noise not exceeding 30 dB, low operational cost
- Consistent color temperature

灯泡 LAMP	
类型 Type:	BLG-120C
色温 Color Temperature:	约6500Kelvin Approx 6500Kelvin
灯泡平均使用寿命 Average lamp life	约50000h Approx 50000h
光通量 Luminous FLux	800lm
控制面板 CONTROL PANEL	
控制面板带有LED灯指示开关按钮，调节光强度上下箭头按钮	
Control panel with LED light indicator switch button, and up and down arrow buttons to adjust light intensity	
兼容Storz, Olympus,Wolf和 ACMI公司产品的导光束接口	
Light Cable socket can be compatible with Storz, Olympus,Wolf and ACMI .	
连通性: 总线接口	
Connectivity: bus interface	
光源电压及功率Voltage and Power 220V AC, 50Hz, 100W	

Xenon Light Source 氙灯冷光源

250W

适用于各种应用和需要的250W氙灯光源，带有用来调节光线强弱的上下箭头及开关按钮。

250 W Xenon light source is suitable for all applications and needs, with up and down button to adjust the light intensity.

灯泡 LAMP	
类型 Type:	BLG-250A
色温 Color Temperature:	约3000-7000Kelvin/Approx 3000-7000 Kelvin
光通量 Luminous FLux:	750lm
控制面板 CONTROL PANEL	
控制面板带有调节光强度上下箭头按钮	
Control panel with up and down button to adjust the light intensity.	
兼容Storz, Olympus,Wolf和 ACMI公司产品的导光束接口	
Light Cable socket can be compatible with Storz, Olympus,Wolf and ACMI .	
连通性: 总线接口	
Connectivity: bus interface	
光源电压及功率Voltage and Power 220V AC, 50Hz, 470VA	

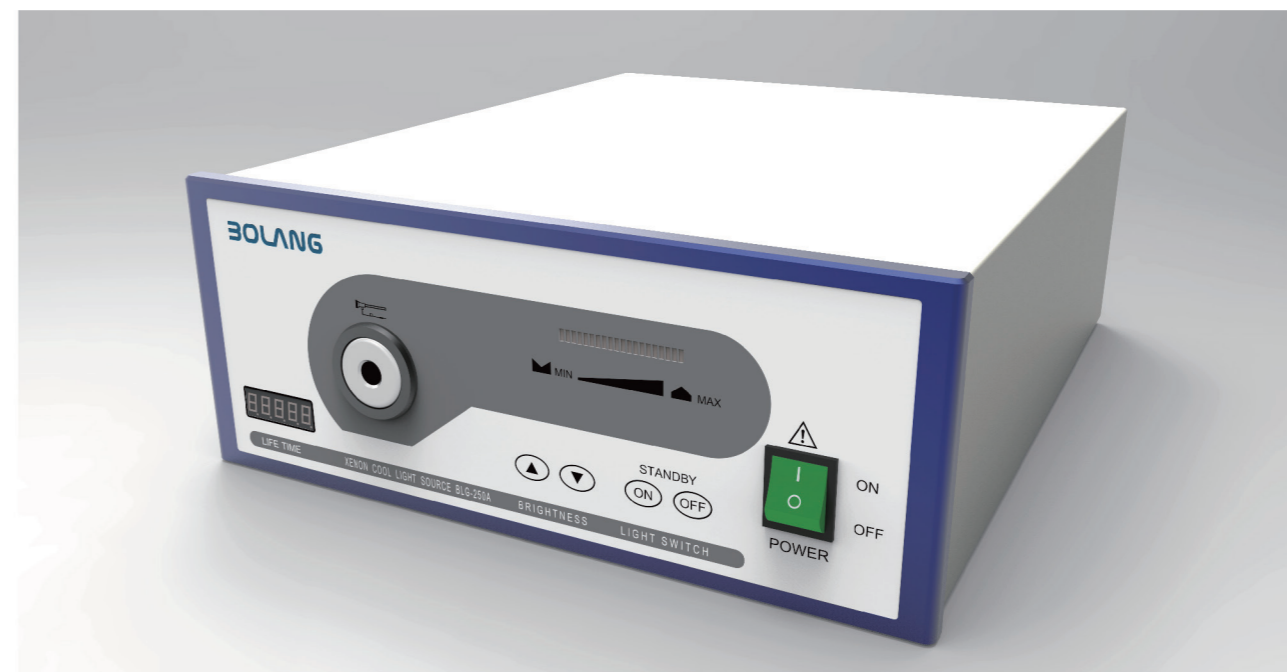

Portable LED Light Source

LED 便携式光源

诊断用高亮度便携式光源，小巧可手持，方便携带使用。适用于博朗所有内窥镜，并配有电池及充电器。

High-bright portable light source for diagnostic purpose, small handheld, easy to carry and use. For all Bolang endoscopes, with battery and charger.



Light cable 导光束

导光束照明亮度一致，可高温高压，且带有颜色代码，可方便区分，存放。并可配有STORZ/WOLF/OLYMPUS导光束适配器。

Uniform illumination and autoclavable, with color code, can be distinguished, stored, easily with STORZ/WOLF/OLYMPUS adapter.



ITEM NO	LENGTH	CLEAR APERTURE	COLOR CODE
型号	长度	通光孔径	颜色代码
JS20DD	2.0m	4.0/4.5/5.0mm	蓝色 Blue
JS25DD	2.5m	4.0/4.5/5.0mm	红色 Red
JS30DD	3.0m	4.0/4.5/5.0mm	绿色 Green

Insufflator 气腹机

该气腹机结合了卓越的性能和安全性。在腹腔镜手术过程中，即使极端条件下，气腹机仍可保持气腹的可靠性。在新生儿模式下，它可增加针对儿科患者的敏感性。

The insufflator combines excellent performance and safety. During laparoscopic surgery, insufflator can maintain the reliability even under the extreme conditions. In neonatal mode, it can increase the sensitivity to paediatric patients.



电压 Voltage	交流220V AC 220V
频率 Frequency	50HZ
功率 Power	50W
电源 Power Supply	750lm 允差-10% 750lm allowance factor -10%

进气压力范围广，从0.1MPa-1MPa均能正常工作
The inlet pressure range is wide and can work normally from 0.1MPa to 1MPa
开机自检，可监测钢瓶压力，并能自动排空管道内空
It can monitor cylinder pressure and empty the pipe automatically.
气压的设定范围为5mmHg -25mmHg，显示允差为±3mmHg
The pressure's set in the range of 5mmHg -25mm Hg, and the tolerance is ±3mmHg.
流速设置范围为1L/min-40L/min，流速实时显示
The velocity is setting in the range of 1L / min-40L / min, and the velocity is displayed in real time.
带流量监测，流量记录可清零
With flow monitoring, flow record can be cleared
超压有声光报警，并自动停止加气，超过设定值5mmHg自动泄压，确保患者安全
Overpressure has sound and light alarm, and stop aeration automatically, automatic pressure relief if setting value over 5mmHg to ensure patients safety.
带用户设定记忆功能，关机后重开机自动记忆用户设定值
With user setting memory function, save user setting value automatically after shutdown.
有正常加气和快速加气两种模式
Two modes of aeration :normal aeration and rapid aeration
可提供中英文两种语言切换
English and Chinese languages are available

广泛的效率确保最佳性能:

- 宽流量范围
- 兼容的语音命令
- 内置燃气加热技术
- 可升级新的软件

Broad efficiency ensures optimal performance:

- Wide flow range
- Compatible voice commands
- Built-in gas heating technology
- Upgraded new software