



**B** 博朗科技

# BOLANG ENDOSCOPE

天津博朗科技发展有限公司

TIANJIN BOLANG SCIENCE-TECHNOLOGY DEVELOPMENT CO.,LTD



# 公司简介:

TIAN JIN BOLANG SCIENCE AND TECHNOLOGY DEVELOPMENT CO., LTD

## BRIEFINTRODUCTION

天津博朗科技发展有限公司坐落于中国—天津海泰绿色产业基地,专业开发和制造内窥镜系统和其它医疗设备的企业,是集研发、制造、销售为一体的高科技专业制造公司,本企业产品覆盖泌尿科、妇科、骨科、普外科、耳鼻喉科、整形外科及工业、科研与领域,企业拥有先进的生产设备、检测设备和受过高等教育的员工,员工拥有丰富的实践经验。本公司于2005年通过ISO9001质量体系,ISO13485医疗设备体系认证,并在2007年获得欧共体CE认证,产品现以覆盖国内外市场,我们的经营态度是:“对病人负责,对医生负责,对我们自己产品负责”。

本公司主要产品:医用内窥镜、医用摄像系统、医用冷光源、医用内窥镜手术器械、气压弹道碎石系统、绿激光治疗系统等。

The manufacturer is seated at Tianjin Hi-tech Green Industry Base, a high-tech enterprise integrating scientific research, manufacture and distribution. The Certification Of Quality Management System For Medical Device ISO9001 and ISO 13485 had been owned in 2005. Meanwhile, CE mark from Europe had been owned in 2007. Now the production has been distributed to every province in China and abroad as well.

### Main Products:

Medical Endoscope, Medical Image Displaying System, Medical Operation Instruments and Lithoclast System etc.

# 博朗科技为人类造福!

Serve For Human Health

### ●专业厂家

Professional Manufacturer

### ●专业开发产品

Professional Products

Certificate证书



## 产品种类货号及编号原则

Code & Serial number rule

### A. 编号原则 Rule

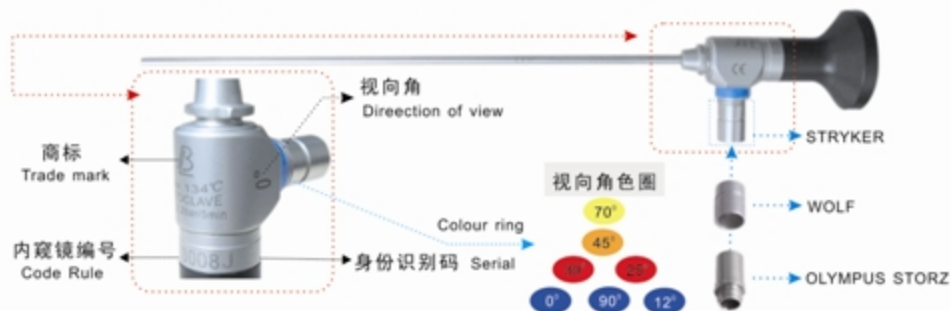

### B. 产品品名按科室分为如下: Products:

#### 泌尿外科 Urology

品名 CODE	产品名称 NAME
PG	尿道膀胱镜 Cysto-Urethroscope
DQ	手术镜(汽化电切镜) Vaporized Resectoscope For Adults
JP	经皮肾镜 Uretero-Renoscope
ND	尿道电切镜 Optical Urethrotome
SS	膀胱碎石镜 Lithotriroscope

#### 骨科 Orthopaedics

品名 CODE	产品名称 NAME
XG	关节镜 Arthroscope

#### 胸腹外科 Thora-laparoscopy

品名 CODE	产品名称 NAME
FQ	腹腔镜 Laparoscopy

#### 耳鼻喉科 E. N. T

品名 CODE	产品名称 NAME
BD	鼻窦镜 Sinoscope
HO	喉镜 Laryngoscope
ZH	支撑喉镜 Operating laryngoscope
ER	耳镜 Otoscope

#### 附属设备 Accessories

品名 CODE	产品名称 NAME
BLG	冷光源 Cold light source
NT	摄像机 Video camer
JS	监视器 Color Monoitor
GL	光缆 Light cable
QF	气腹机 Laparo co <sub>2</sub> -pneu
QD	气压弹道碎石仪
JK	光学接口 Adapter (optic coupler)
YX	图文工作站 Software for endoscopy
TC	仪器台车 Mobile Video

#### 妇科 Gynecology

品名 CODE	产品名称 NAME
GD	手术镜(宫腔电切镜) Hystero-Electrome
GJ	宫腔镜检查镜 Hysteroscope for inspection

## 光学接口型号及可供物镜焦距对照表

备注: KS:摄像接口 KZ:转换接口 SC:双通接口 C:国产镜 O:OLYMPUS纤维镜 P:PENTAX纤维镜 R(Y):硬型镜  
18:1代表162摄像机, 8代表822摄像机

型号	产品名称			各接口可选配物镜焦距	
XZP	接口	直通	PENTAX纤维镜直通C接口	Pentax coupler indirect	$f =$ <ul style="list-style-type: none"> <li><input type="checkbox"/> F15</li> <li><input type="checkbox"/> F18</li> <li><input type="checkbox"/> F20</li> <li><input type="checkbox"/> F21</li> <li><input type="checkbox"/> F22</li> <li><input type="checkbox"/> F25</li> <li><input type="checkbox"/> F28</li> <li><input type="checkbox"/> F30</li> <li><input type="checkbox"/> F32</li> <li><input type="checkbox"/> F35</li> </ul>
YZC			硬管镜直通C接口	Couplev indirect for vigid	
XZO			OLYMPUS纤维直通C接口	Olympus coupler indirect	
YSC		双通	硬管镜双通C接口	Couplev indirect for double	
XSP			纤维镜双通C接口接PENTAX纤维镜	Flex coupler indirect for pentax	
XSO			纤维镜双通C接口接OLYMPUS纤维镜	Flex coupler indirect for olympus	
KS-P		直通	PENTAX纤维镜直通接口 (接162或822摄像机)	The direct for pentax flexible	
KS-Y			硬管镜直通接口 (接162或822摄像机)	The direct for rigid	
KS-O		双通	OLYMPUS纤维直通接口 (接162或822摄像机)	The direct for olympus flexible	
KS-SP			Pentax纤维镜双通接口 (接162或822摄像机)	The double for pentax flexible	
KS-SO		硬管镜双通接口 (接162或822摄像机)	OLYMPUS硬管镜双通接口 (接162或822摄像机)	The double for olympus rigid	
KS-SP			The double for rigid		
Y/P		转换器	原硬管镜转PENTAX纤维镜	The flexible reduced from pentax to coupler	
Y/O			原硬管镜转OLYMPUS纤维镜	The flexible reduced from olympus to coupler	
P/Y			原PENTAX纤维镜转硬管镜	The coupler reduced from pentax to rigid	
O/Y			原OLYMPUS纤维镜转硬管镜	The coupler reduced from olympus to rigid	
O/P	原OLYMPUS纤维镜转PENTAX纤维镜		The coupler reduced from pentax to flexible		

## 光源端型号及转换器对照表

型号	产品名称		
GL-P/O	光源端 转换接口	原PENTAX纤维镜转OLYMPUS型光源端插头	The Pentax or olympus
GL-O/W		原接OLYMPUS纤维镜转WOLF型光源端插头	The olympus or wolf
GL-P/W		原接PENTAX纤维镜转WOLF型光源端插头	The Pentax or wolf
GL-P/S		原PENTAX纤维镜转STOTZ型光源接口	The pentax or stotz
GL-P/STR		原PENTAX纤维镜转STRYKER型光源接口	The Pentax or stryker

# 硬管内窥镜目录

## Rigid Endoscope list



序号 No	代码 Code	品名 Name of commodity	外径 Outer diameter	视向角 Direction of view	工作长度 Working Length	视场角 Field of view
1	ER0027050	耳镜 Otoscope	2.9-2.7mm	0°	60-50mm	
2	ER3027050	耳镜 Otoscope	2.9-2.7mm	30°	60-50mm	
3	ER0027100	耳鼓室镜 Otoscope for tympanum	2.9-2.7mm	0°	100mm	
4	ER3027100	耳鼓室镜 Otoscope for tympanum	2.9-2.7mm	30°	100mm	
5	XG0027165	小儿关节镜 Arthroscope	2.9-2.7mm	0°	175mm	
6	XG3027165	小儿关节镜 Arthroscope	2.9-2.7mm	30°	175mm	
7	BD0027175	小儿鼻窦镜 Sinoscope	2.9-2.7mm	0°	175mm	
8	BD3027175	小儿鼻窦镜 Sinoscope	2.9-2.7mm	30°	175mm	
9	PG0027190	小儿膀胱镜 Cystoscope	2.9-2.7mm	0°	190mm	
10	PG3027190	小儿膀胱镜 Cystoscope	2.9-2.7mm	30°	190mm	
11	ER0040050	耳镜 Otoscope	4.0mm	0°	60-50mm	
12	ER3040050	耳镜 Otoscope	4.0mm	30°	60-50mm	
13	XG0040165	关节镜 Arthroscope	4.0mm	0°	175mm	
14	XG3040165	关节镜 Arthroscope	4.0mm	30°	175mm	
15	XG7040165	关节镜 Arthroscope	4.0mm	70°	175mm	
16	BD0040175	鼻窦镜 Sinoscope	4.0mm	0°	175mm	
17	BD3040175	鼻窦镜 Sinoscope	4.0mm	30°	175mm	
18	BD7040175	鼻窦镜 Sinoscope	4.0mm	70°	175mm	
19	PG0040302	尿道膀胱镜 Cystoscope	4.0mm	0°	301mm	
20	PG1240302	尿道膀胱镜 Cystoscope	4.0mm	12°	301mm	
21	PG3040302	尿道膀胱镜 Cystoscope	4.0mm	30°	301mm	
22	PG7040302	尿道膀胱镜 Cystoscope	4.0mm	70°	301mm	
23	FQ0050310	腹腔镜 Laparoscope	5.0mm	0°	310mm	
24	FQ3050310	腹腔镜 Laparoscope	5.0mm	30°	310mm	
25	FQ0010330	腹腔镜 Laparoscope	10.0mm	0°	330mm	
26	FQ3010330	腹腔镜 Laparoscope	10.0mm	30°	330mm	
27	HO7060187	喉镜 Laryngoscope	6.0mm	70°	175mm	
28	HO9060187	喉镜 Laryngoscope	6.0mm	90°	175mm	
29	HO7080187	喉镜 Laryngoscope	8.0mm	70°	175mm	
30	HO9080187	喉镜 Laryngoscope	8.0mm	90°	175mm	
31	HO7010187	喉镜 Laryngoscope	10.0mm	70°	175mm	
32	HO9010187	喉镜 Laryngoscope	10.0mm	90°	175mm	
33	XG0040165 W/A	广角关节镜 Arthroscope, wide angle	4.0mm	0°	175mm	
34	XG3040165 W/A	广角关节镜 Arthroscope, wide angle	4.0mm	30°	175mm	
35	XG7040165 W/A	广角关节镜 Arthroscope, wide angle	4.0mm	70°	175mm	
36	BD0040175 W/A	广角鼻窦镜 Sinoscope, wide angle	4.0mm	0°	175mm	
37	BD3040175 W/A	广角鼻窦镜 Sinoscope, wide angle	4.0mm	30°	175mm	
38	BD7040175 W/A	广角鼻窦镜 Sinoscope, wide angle	4.0mm	70°	175mm	



## 1. Specification 产品原则

公司简介	Brief introduction
内窥镜编号原则	Number rule for rigid Endoscopes
硬管内窥镜目录	Rigid Endoscope list
器械编号原则	Number rule for rigid Instruments

## 2. Urology 泌尿外科

尿道膀胱镜	Cysto-Urethroscope
侧视尿道膀胱镜	Cysto-Urethroscope for laterl view
汽化电切镜	Resectoscope
尿道内切镜	Urethrotome
膀胱碎石镜	Lithotriptoscope
肾输尿管镜(经皮肾镜)	Uretero-Renoscope

## 3. Gynecology 妇科

宫腔检查镜	Hysteroscope For Inspection
宫腔电切镜	Hystero-Electrome
电动子宫切割器	Electric uterus-Cutter and en-losure
妇科器械	Gynaecology Instrument

## 4. Laparoscopy 胸腹外科

腹腔镜	Laparoscopy
腹腔镜手术器械	Laparoscopy instruments

## 5. E.N.T 耳鼻喉科

鼻窦镜	Sinoscope
鼻窦镜手术器械	Sinoscope instruments
支撑喉镜	Operating laryngoscope
耳镜	Otoscope

## 6. Arthroscopy 骨科

关节镜	Arthroscope
-----	-------------

## 7. Accessories 附属设备

冷光源	Cold light source
摄像机	Video camera
导光束	Fiberoptic light cable
光学接口	Adapter(optic coupler)



# Urology

## 泌尿外科

- |          |  |       |
|----------|--|-------|
| <b>1</b> | 尿道膀胱镜<br>Cysto-Urethroscope                    | 2-4   |
| <b>2</b> | 侧视尿道膀胱镜<br>Cysto-Urethroscope for lateral view | 5     |
| <b>3</b> | 汽化电切镜<br>Resectoscope                          | 6-10  |
| <b>4</b> | 尿道内切镜<br>Urethrotome                           | 11-12 |
| <b>5</b> | 膀胱碎石镜<br>Lithotripsy                           | 13    |
| <b>6</b> | 肾输尿管镜(经皮肾镜)<br>Uretero-Renoscope               | 14-18 |













## 尿道膀胱镜 CYSTO-URETHROSCOPE



Φ4.0mm  
4毫米膀胱内窥镜  
Cysto-Urethroscope

Φ4.0mm  
Cystoscope



型号 Art.-No.	视角 Direction	工作长度 Working length	直径 Out Diameter	颜色代码 Color code	(成人) Adults
PG 0004301	0° 	301mm	4mm	蓝 blue	
PG 1204301	12° 	301mm	4mm	蓝 blue	
PG 2504301	25° 	301mm	4mm	红 red	
PG 3004301	30° 	301mm	4mm	红 red	
PG 7004301	70° 	301mm	4mm	黄 yellow	
PG 0029190	0° 	190mm	2.9mm	蓝 blue	(小儿) Pediatrics
PG 1229190	12° 	190mm	2.9mm	蓝 blue	
PG 2529190	25° 	190mm	2.9mm	红 red	
PG 3029190	30° 	190mm	2.9mm	红 red	
PG 7029190	70° 	190mm	2.9mm	黄 yellow	

### 膀胱镜鞘

### Sheath

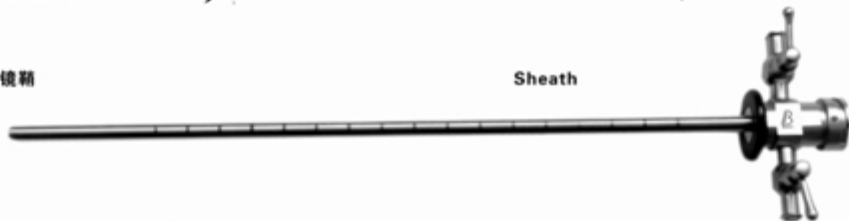

型号 Art.-No.	尺寸 French (Fr)	
PG 110150Q	F11 (11Fr)	小儿镜鞘 Sheath for Pediatrics
PG 155230Q	F15.5 (15.5Fr)	成人镜鞘 Sheath for Adults
PG 198230Q	F19.8 (19.8Fr)	
PG 210230Q	F21 (21Fr)	
PG 225230Q	F22.5 (22.5Fr)	



闭孔器 OBTURATOR



型号 Art.-No.	工作长度 Working length
PG 155230Q1	F11×150
PG 198230Q1	F15.5×230
PG 210230Q1	F19.8×230
PG 225230Q1	F21×230
PG 110150Q1	F22.5×230

操作器 OPERATING INSTRUMENT



型号 Art.-No.	描述 Description
----------------	-------------------

PG 02CS 出水接头  
Water-out valve



PG 02RS 进水接头  
Water-in valve



PG 03DQ 单镜桥 Single Bridge  
PG 03SQ 双镜桥 Double Bridge

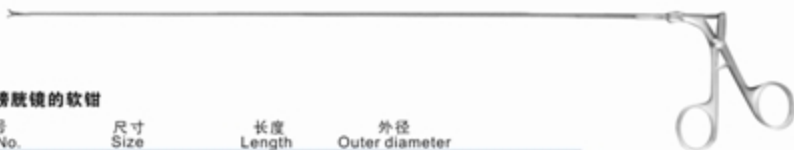

用于膀胱镜的软钳

型号 Art.-No.	尺寸 Size	长度 Length	外径 Outer diameter
软性活检钳 Flexible biopsy forceps			
PG 7280RH	7	F7×280	2.3mm
PG 5280RH	5	F5×280	1.6mm
软性齿抱钳 Flexible barb-holding forceps			
PG 7280RH	7	F7×280	2.3mm
PG 5280RC	5	F5×280	1.6mm
软性异物钳 Flexible foreign body forceps			
PG 7280RH	7	F7×280	2.3mm
PG 5280RY	5	F5×280	1.6mm
软性剪刀 Flexible scissors			
PG 7280RH	7	F7×280	2.3mm
PG 5280RJ	5	F5×280	1.6mm



可调式尿道扩张器 ADJUSTABLE URETHRA DILATOR



清洗杆

CLEANING POLE

PG06QS



尿道膀胱镜配套用内窥镜

ENDOSCOPIC FORCEPS FOR THE CYSTO-URETHROSCOPE



型号  
Art.-No.

描述  
Description

PG 01YH

小杯活检钳  
Biopsy spoon forceps



PG 02YW

弯杯活检钳  
Biopsy forceps, Spoon angled 90°



PG 03YY

异物钳  
Foreign body forceps



PG 04YJ

弧头双剪  
Double scissors "curved"



PG 05YQ

弯头咬切钳  
Forceps curved cutting



## 侧视式尿道膀胱镜 SIDE-VIEWING CYSTO-URETHROSCOPE

可用于深道膀胱的检查和平术，也可用于弹道碎石机的配套使用，进行膀胱等碎石手术。

Be the examination and surgery of the urethra and bladder also can be used with lithoclast to smash stones of the bladder.

型号 Art.-No.	描述 Description	长度 Length
----------------	-------------------	--------------

PG C0604210	内窥镜 Endoscope	F23*210 器械通道F13.5 Instrument channel
-------------	------------------	--

PG C23210Q	镜鞘 Endoscope bridge	F23*210
------------	------------------------	---------

PG C23210Q1	闭孔器 Obturator	F23
-------------	------------------	-----

PG C01RS	进水接门 Water-in valve	
----------	------------------------	--

PG C02CS	出水接门 Water-out valve	
----------	-------------------------	--

### 硬性手术钳 RIGID OPERATING FORCEPS

型号 Art.-No.	描述 Description	外径 Outer diameter
----------------	-------------------	----------------------

PG C01YJ	剪刀 Scissors	2mm
----------	----------------	-----



PG C02YH	活检钳 Biopsy forceps	2mm
----------	-----------------------	-----

PG C03YY	异物钳 Foreign body forceps	2mm
----------	-----------------------------	-----



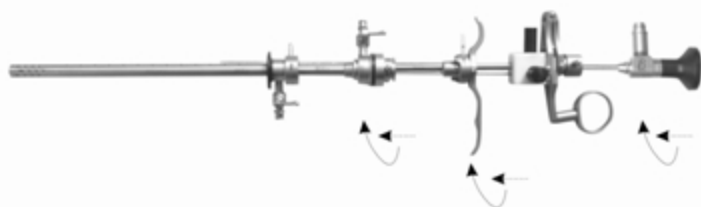
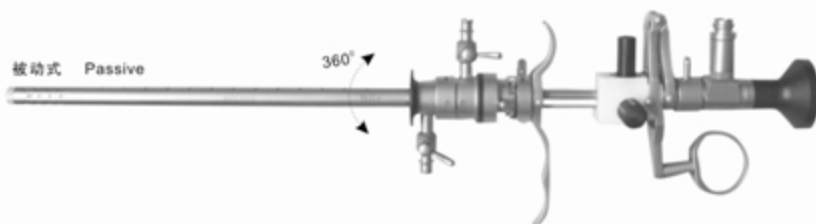

## 汽化电切镜 VAPORIZED RESECTOSCOPE



型号 Art-No.	视角 Direction	工作长度 Working length about	直径 Out Diameter	颜色代码 Color code	(成人) Adults
DQ 1204301	12° 	301mm	4mm	蓝 blue	
DQ 2504301	25° 	301mm	4mm	蓝 blue	
DQ 3004301	30° 	301mm	4mm	红 red	

型号 Art-No.	视角 Direction	工作长度 Working length about	直径 Out Diameter	颜色代码 Color code	(小儿) Pediatrics
DQ 1229190	12° 	190mm	2.9mm	蓝 blue	
DQ 2529190	25° 	190mm	2.9mm	蓝 blue	
DQ 3029190	30° 	190mm	2.9mm	红 red	

型号 Art.-No.	描述 Description
----------------	-------------------

DQ255WQ	外鞘 Outer sheath
---------	--------------------



DQ24NQ	内鞘 Inner sheath
--------	--------------------



### 电切器

#### 被动式电切器 Working element, passive

型号 Art.-No.	描述 Description
DQ1000BD	被动式电切器 Working element, passive

(成人)  
Adults

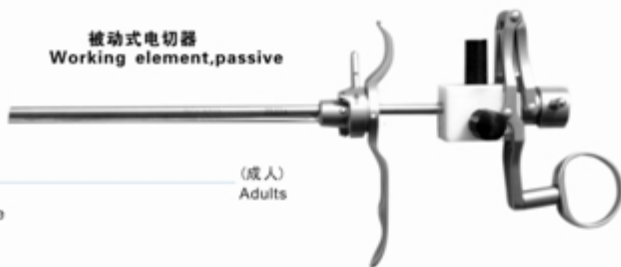

型号 Art.-No.	描述 Description
DQ2000BD	被动式电切器 Working element, passive

(小儿)  
Pediatrics

#### 主动式电切器 Working element, active

型号 Art.-No.	描述 Description
DQ1000ZD	主动式电切器 Working element, active

(成人)  
Adults

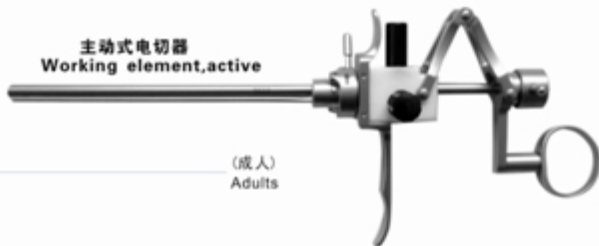

型号 Art.-No.	描述 Description
DQ2000ZD	主动式电切器 Working element, active

(小儿)  
Pediatrics



泌尿外科  
Urology

DQ255WQ1 外鞘闭孔器  
Outer sheath obturator (active) 

耳鼻喉科  
E.N.T

DQ24NQ1 内鞘闭孔器  
Inner sheath obturator 

妇科  
Gynecology

DQ03QS 清洗杆  
Cleaning pole 

胸腹外科  
Thora-Laparoscopy

### 造漏器 FISTULA

型号 Art.-No.	描述 Description
----------------	-------------------

DQ01DN	导尿管 Lead urine implement	
--------	-----------------------------	---

骨科  
Orthopaedics

DQ01NQ	内鞘 Inner sheath	
--------	--------------------	--

DQ01CC	穿刺针 Trocar	
--------	---------------	--

附属设备  
Accessories

DQ02ZL	引流管	
--------	-----	--



型号 Art.-No.	描述 Description	
DQ1001H	环状电极	Hook electrode
DQ2001H	环状电极(小儿)	Ring electrode paediatric



DQ1002Z	针式汽化环	Cutting loop-thick
DQ2002Z	针式汽化环(小儿)	Needle cutting loop paediatric



DQ1003D	电凝环	Coagulating electrode, barrel type
DQ2003D	电凝环(小儿)	Coagulating electrode, barrel type paediatric



DQ1004C	齿式汽化环	Spike electrode
DQ2004C	齿式汽化环(小儿)	Spike electrode Paediatric



DQ1005Q	球式电切环	Ball cutting loop
DQ2005Q	球式电切环(小儿)	Ball cutting loop Paediatric



DQ1006C	槽式汽化环	Groovy cutting loop
DQ2006C	槽式汽化环(小儿)	Groovy cutting loop Paediatric



泌尿外科  
Urology

耳鼻喉科  
E.N.T

妇科  
Gynecology

胸腹外科  
Thora-Laparoscopy

骨科  
Orthopaedics

附属设备  
Accessories

泌尿外科  
Urology

针筒式冲洗器



DQ1075BX

耳鼻喉科  
E.N.T

型号  
Art.-No.

描述  
Description

妇科  
Gynecology

DQ1075BX1

针筒式冲洗器接头  
Irrigator connector with  
suyringge shaps



胸腹外科  
Thora-Laparoscopy

DQ1075BX2

针筒式冲洗器接头  
Irrigator connector with  
suyringge shaps



骨科  
Orthopaedics

DQ1076CX

冲吸器  
Forkman



DQ1077CX

冲吸器  
Allik



附属设备  
Accessories

DQ04BX

拔血器  
Blood suction unit



尿道内切镜 OPTICAL URETHROTOME



型号 Art.-No.	视角 Direction	工作长度 Working length	直径 Out Diameter	颜色代码 Color code
ND 0004301	0° 	301mm	4mm	蓝 blue
ND 1204301	12° 	301mm	4mm	蓝 blue
ND 2504301	25° 	301mm	4mm	红 red
ND 3004301	30° 	301mm	4mm	红 red

型号 Art.-No.	视角 Direction	工作长度 Working length	直径 Out Diameter	颜色代码 Color code
ND 0029190	0° 	190mm	2.9mm	蓝 blue
ND 1229190	12° 	190mm	2.9mm	蓝 blue
ND 2529190	25° 	190mm	2.9mm	红 red
ND 3029190	30° 	190mm	2.9mm	红 red

型号 Art.-No.	描述 Description
ND22210WQ	鞘管 Sheath
ND228Q	中空闭孔器 Hollow dbturator
ND238Q	半鞘 Guide tube
ND3000BD	被动式内切开器 Passive urethrotome



内切刀 INSCRIBE KNIFE



型号 Art.-No.	描述 Description
----------------	-------------------

ND3001BY	半月刀 Knife, semi-circular
----------	-----------------------------



ND3002LY	柳叶刀 Knife, lancet type
----------	---------------------------



ND3003LY	镰形刀 Knife, sickle-shaped
----------	-----------------------------



ND3004ZK	中空半月刀 Knife, round
----------	-----------------------



气压弹道碎石仪

型号 Art.-No.	描述 Description
----------------	-------------------

QD50SS	气压弹道碎石仪
--------	---------



大力碎石镜 LITHOTRIPTOSCOPE



可直接由尿道进入膀胱进行碎石  
Can be inserted into bladder through urethra directly to smash the stone

型号 Art.-No.	描述 Description
----------------	-------------------

SS4000SQ	大力碎石钳 与70°内窥镜配套使用 For lithotripsy, (70 degree)
----------	--



拉式碎石钳

LITHOCLAST

型号  
Art.-No.

描述  
Description

SS 4000LQ

大力碎石钳  
与0°内窥镜配套使用  
For lithotripsy scope (30 degree)

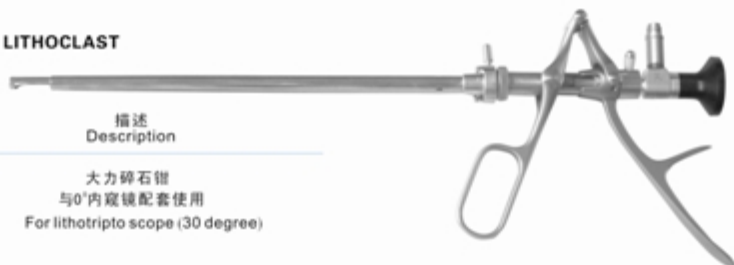

咬式碎石钳

STONE CRUSHING FORCEPS

型号  
Art.-No.

描述  
Description

SS 4000YQ

大力碎石钳  
与30°内窥镜配套使用  
For lithotripsy scope (30 degree)



型号  
Art.-No.

描述  
Description

SS 0004310

0° 内窥镜  
Endoscope



SS 1002QX

钳芯  
Sheath



SS 1001QX

钳芯  
Inner sheath



SS 1003BK

闭孔器  
Obturator



SS 1004BX

冲洗器接头  
connector with  
suyringge shapes



肾输尿管镜(经皮肾镜) URETERO-RENSCOPE



肾输尿管镜配套器械

型号 Art.-No.	描述 Description	工作长度 Working length
----------------	-------------------	------------------------

JP1001KZ— JP1006KZ	扩张器 Dilator	F7/F8/F9/ F10/F12
-----------------------	----------------	----------------------



JP1007DJ	电极 Electrode	580mm
----------	-----------------	-------



RIGID BIOPSY  
FORCEPS

JP1008YH	硬性活检钳 Rigid biopsy forceps	580mm
----------	-------------------------------	-------



JP1008RH	软性活检钳 Flexible biopsy forceps	580mm
----------	----------------------------------	-------









JP1008YJ	硬性锯齿钳 Rigid grasping forceps	580mm
----------	---------------------------------	-------



JP1008YY	硬性异物钳 Rigid foreign body forceps	580mm
----------	-------------------------------------	-------



型号 Art.-No.	描述 Description	
JP1010DS	导丝 Fuse	
JP1010SZ	四爪钳 Forceps with 4 claws	
JP1012SZ	三爪钳 Forceps with 3 claws	
JP1013LT	螺旋形套石篮 Spiral stae basket	
JP1014LT	篮形套石篮 Stone basket	
JP1015ST	三通接阀 Valve with 3 channel	

泌尿外科  
Urology

型号  
Art.-No.

描述  
Description

JP2001WK

弯头尿道扩张切开器  
Urethrotomy (curved head)



耳鼻喉科  
E.N.T.

JP2002ZK

直头尿道扩张切开器  
Urethrotomy (straight head)



妇科  
Gynecology

JP2003LK

连续扩张器  
Dilator



胸腹外科  
Thora-Laparoscopy

JP2004KK

可调式尿道扩张器  
Adjustable urethra dilator



骨科  
Orthopaedics

JP2005XJ

阴茎夹  
Penis clamp



JP2006DY

导尿管导引器  
Catheter guide



附属设备  
Accessories

JP2007QL







前列腺拉钩  
Fraw hook for prostate



JP2008SC

肾穿刺针  
Kidney needle for puncture



型号 Art.-No.	外径 Outer diameter	描述 Description	
JP1032SK	F11	丝状探条扩张器 Silk-shaped dilator in probe	
JP1033SK	F12		
JP1034SK	F13		
JP1035SK	F14		
JP1036SK	F15		
JP1037SK	F18		
JP1038SK	F21		
JP1039SK	F24		
JP1040SK	F27		
JP1041MK	F8	男性尿道扩张器 Dilator for male	
JP1041MK	F10		
JP1042MK	F12		
JP1043MK	F14		
JP1044MK	F16		
JP1045MK	F18		
JP1046MK	F20		
JP1047MK	F22		
JP1048MK	F26		
JP1049MK	F28		
JP1050MK	F30		
JP1051MK	F32		
JP1052NK	F18	女性尿道扩张器 Dilator for female	
JP1053NK	F24		
JP1054NK	F30		
JP1055NK	F36		
JP1056NK	F42		
JP1057MD	F9	男性金属导尿管 Ureteral catheter for male	
JP1058MD	F12		
JP1059MD	F15		
JP1060MD	F18		
JP1061MD	F24		
JP1062ND	F18	女性金属导尿管 Ureteral cathetre for female	
JP1063ND	F20		
JP1064ND	F22		
JP1065ND	F24		
JP1066ND	F26		
JP1067ND	F28		
JP1068ND	F30		
JP1069ST	F2	丝状探条 Silk-shaped probe	
JP1060ST	F3		
JP1071ST	F4		
JP1072ST	F5		
JP1073ST	F6		
JP1074KK	F14×F32×110	尿道口扩张器 Dilator for urethra	



泌尿外科  
Urology

肾穿刺针 TROCAR



耳鼻喉科  
E.N.T

妇科  
Gynecology

型号  
Art.-No.

描述  
Description



JP1074CC

肾穿刺针  
Trocar

胸腹外科  
Thora-Laparoscopy

肾扩张器

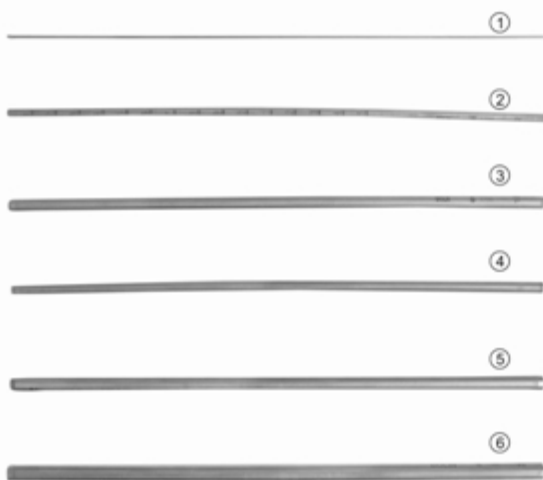

骨科  
Orthopaedics

型号  
Art.-No.

描述  
Description

JP1075CZ

肾扩张器

附属设备  
Accessories









# Gynecology

## 妇科

- |          |                                      |       |
|----------|--------------------------------------|-------|
| <b>1</b> | 宫腔检查镜 .....                          | 20-23 |
|          | Hysteroscope For Inspection          |       |
| <b>2</b> | 宫腔电切镜 .....                          | 24-27 |
|          | Hystero-Electrome                    |       |
| <b>3</b> | 电动子宫切割器 .....                        | 28-29 |
|          | Electric uterus-Cutter and enclosure |       |
| <b>4</b> | 妇科器械 .....                           | 30-31 |
|          | Gynaecology Instrument               |       |





型号 Art.-No.	视角 Direction	工作长度 Working length	颜色代码 Color code	直径 Out Diameter
GJ 1204301	12° 	301mm	蓝 blue	4mm
GJ 2504301	25° 	301mm	红 red	4mm
GJ 3004301	30° 	301mm	红 red	4mm
GJ 1229301	12° 	301mm	蓝 blue	2.9mm
GJ 2529301	25° 	301mm	红 red	2.9mm
GJ 3029301	30° 	301mm	红 red	2.9mm

### 宫腔检查镜-A HYSTEROSCOPE SET FOR INSPECTION-A



### 外鞘 Outer sheath



型号 Art.-No.	描述 Description	外径 Out diameter
GJ 15442WQ	外鞘 Outer sheath	4.42mm
GJ 15516WQ	外鞘 Outer sheath	5.16mm

泌尿外科  
Urology

耳鼻喉科  
E.N.T

妇科  
Gynecology

胸腹外科  
Thora-Laparoscopy

骨科  
Orthopaedics

附属设备  
Accessories

### 镜鞘 INNER SHEATH



型号 Art.-No.	描述 Description	外径 Out diameter
GJ15608NQ	内鞘 Inner sheath	6.08mm
GJ15650NQ	内鞘 Inner sheath	6.50mm

### 闭孔器 OBTUATOR



型号 Art.-No.	描述 Description
GJ12240NQ1	闭孔器 Obturator

### 内窥镜 OPTICAL FORCEPS FOR CYSTOSCOPE



型号 Art.-No.	描述 Description
GJ2000QZ	内窥镜 Optical forceps for cystoscope

### 宫腔镜检查-B HYSTEROSCOPE SET FOR INSPECTION-B

**特点**  
Features

采用弯管设计，符合人体机理，操作方便，可以对宫腔进行活检、取异物等手术盒检查。

Curved tube design, comply with humen structure, easy to handle, can be used to do biopsy, foreign body taking surgery and examination in uterinecavity.



型号 Art.-No.	描述 Description	规格 Specification
GJ2264178	22°弯管内窥镜 Side-viewing endoscope	Φ6.4×178
GJ2244178	22°弯管内窥镜 Side-viewing endoscope	Φ4.4×178

### 宫腔镜检查-C HYSTEROSCOPE SET FOR INSPECTION-C

**特点**  
Features

可以产生循环水流以保持清晰图像，可以通过F6器械通道进行宫腔手术及检查。

Can be generate cycling water to keep clear image for uterine cavity surgery with instrument channel F6



型号 Art.-No.	描述 Description	规格 Specification
GJ48310	操作器 Working element	Φ 4.8×310
GJ24178	操作鞘套 Sheath	F24×178

### 宫腔镜检查-D HYSTEROSCOPE SET FOR INSPECTION-D

特点  
Features

可以产生循环水流以保持清晰图像，可以通过F6器械通道进行宫腔手术及检查。  
Can be generate cycling water to keep clear image for uterine cavity surgery with instrument channel F6



型号 Art.-No.	描述 Description	规格 Specification
GJ24240	外鞘 Outer sheath	F24×240
GJ20250	内鞘 Inner sheath	F20×250

#### 用于宫腔镜的软钳

型号 Art.-No.	尺寸 Size	长度 Length	外径 Outer diameter
<b>软性活检钳</b> Flexible biopsy forceps			
PG 7280RH	7	F7×280	2.3mm
PG 5280RH	5	F5×280	1.6mm
<b>软性齿钳</b> Flexible barb-holding forceps			
PG 7280RH	7	F7×280	2.3mm
PG 5280RC	5	F5×280	1.6mm
<b>软性异物钳</b> Flexible foreign body forceps			
PG 7280RH	7	F7×280	2.3mm
PG 5280RY	5	F5×280	1.6mm
<b>软性剪刀</b> Flexible scissors			
PG 7280RH	7	F7×280	2.3mm
PG 5280RJ	5	F5×280	1.6mm



泌尿外科  
Urology

耳鼻喉科  
E.N.T

妇科  
Gynecology

胸腹外科  
Thora-Laparoscopy

骨科  
Orthopaedics

附属设备  
Accessories

宫腔电切镜 RESECTOSCOPE FOR ADULTS

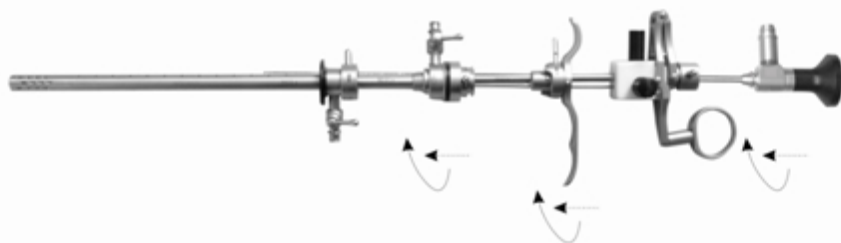
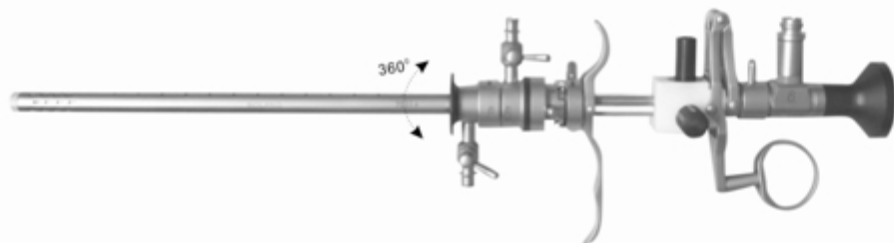

型号 Art.-No.	视角 Direction	工作长度 Working length	直径 Out Diameter	颜色代码 Color code
GD0004301	0°	301mm	4mm	蓝 blue
GD1204301	12°	301mm	4mm	蓝 blue
GD2504301	25°	301mm	4mm	红 red
GD3004301	30°	301mm	4mm	红 red
GD0029190	0°	190mm	2.9mm	蓝 blue
GD1229190	12°	190mm	2.9mm	蓝 blue
GD2529190	25°	190mm	2.9mm	红 red
GD3029190	30°	190mm	2.9mm	红 red

电切器 WORKING ELEMENT

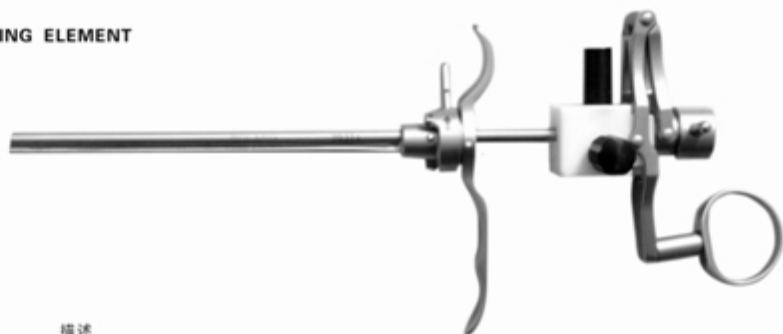

型号 Art.-No.	描述 Description
GD1000BD	被动式电切器 Working element,passive



型号 Art.-No.	描述 Description
GD1000ZD	主动式电切器 Working element,acctive



泌尿外科  
Urology

耳鼻喉科  
E.N.T

妇科  
Gynecology

胸腹外科  
Thora-Laparoscopy

骨科  
Orthopaedics

附属设备  
Accessories

操作鞘 OPERATIVE SHEATH

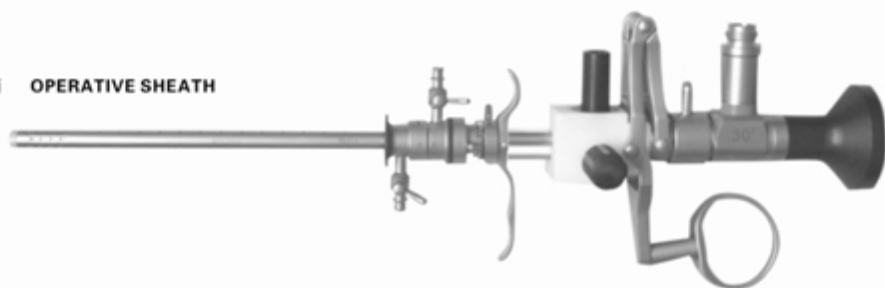

型号 Art.-No.	描述 Description
----------------	-------------------

GD1000WQ	外鞘 Outer sheath
----------	--------------------



GD1000WQ1	外鞘闭孔器 Outer sheath outurator
-----------	---------------------------------



GD1000NQ	内鞘 Inner sheath
----------	--------------------



GD1000NQ1	内鞘闭孔器 Inner sheath outurator
-----------	---------------------------------



GD1003QX	清洗杆 Cleaning pole
----------	----------------------



电极 ELECTRODE



型号 Art.-No.      描述 Description

GD 2001H      环状电极 Hook electrode



GD 2002Z      针式汽化环 Cutting loop-thick



GD 2003D      电凝环 Coagulating electrode, barrel type



GD 2004C      齿式汽化环 Spike electrode



GD 2005Q      球式电切环 Cutting loop



GD 2006C      槽式汽化环 Vaporisation electrode



泌尿外科  
Urology

耳鼻喉科  
E.N.T

妇科  
Gynecology

胸腹外科  
Thora-Laparoscopy

骨科  
Orthopaedics

附属设备  
Accessories

# 电动子宫切割器

ELECTRIC UTERUS-CUTTER AND ENCLOSURE



泌尿外科  
Urology

## 子宫切除器 MORCELLATION

型号  
Art.-No.

描述  
Description

GD15320YQ 阴式切除器  
GD18320YQ Hysterectomy apparatus



耳鼻喉科  
E. N. T

GD10320FQ 腹式切除器  
GD15320FQ Hysterectomy apparatus  
GD18320FQ



妇科  
Gynecology

GD05330TJ 推结器  
Knot-pushing stick



GD05420ZB 子宫拨棒  
Polpation probe



胸腹外科  
Thora-Laparoscopy

GD10330YD 引导棒  
Guide probe



GD05500ZL 子宫量棒  
Uterus measuing stick



骨科  
Orthopaedics

GD10420ZJ 子宫肌瘤钻 400mm(大)  
GD05420ZJ Hysteromya bodkin 400mm(小)



GD1015KZ 穿刺扩张鞘  
GD1018KZ Dilator



GD15ZH 转换器  
GD18ZH Converter



附属设备  
Accessories

GD15CQ 穿刺鞘  
GD18CQ Trocar sleeve



**子宫大抓钳 UTERINE GRASPING FORCEPS**

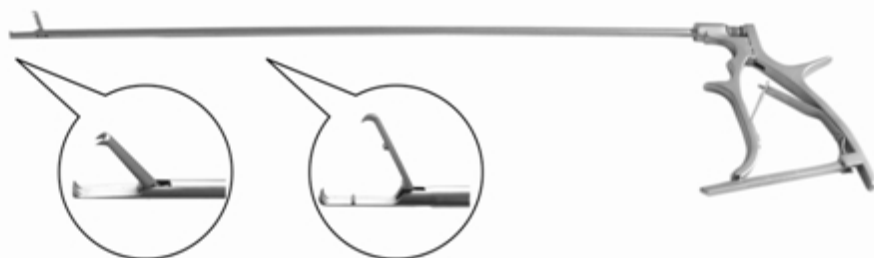

型号 Art.-No.	描述 Description
GD10420ZZ	抓钳
GD05420ZZ	Grasping forceps

型号 Art.-No.	描述 Description
GD22KZ	控制器 Contro unit



型号 Art.-No.	描述 Description
GD23MD	电动马达 Motor



**举宫器 UTERINE MABIPULATOR**

型号 Art.-No.	描述 Description
GD400JG	举宫器 Apparatus



泌尿外科  
Urology

耳鼻喉科  
E. N. T.

妇科  
Gynecology

胸腹外科  
Thora-Laparoscopy

骨科  
Orthopaedics

附属设备  
Accessories

泌尿外科  
Urology

多功能举宫器 TO OPERATE MULTIFUNCTIONAL UTERUS LIFTING APPARATUS



耳鼻喉科  
E.N.T

妇科  
Gynecology

胸腹外科  
Thora-Laparoscopy

骨科  
Orthopaedics

附属设备  
Accessories

型号  
Art.-No.

描述  
Description

GD08SB

手柄  
Handle



GD09CZ

操纵杆  
Manipulative pole



GD10SG

锁杆  
To lock up pole



GD11YD

引导棒  
Guide probe



GD12JG

举宫杯  
Apparatus cup



GD13CZ

操纵头  
Manipulative head



无创伤抓钳 ARTRAUMATIC SPRING GRASPING FORCEPS



型号 Art.-No.	外径 Outer diameter	长度 Length
GD03WZ	5mm	330mm

双抓肌瘤抓钳 DOUBLE GRASPING FORCEPS



型号 Art.-No.	描述 Description
GD06SZ	双抓肌瘤抓钳 Double grasping forceps

宫颈钳 CERVICAL CLAMPS



型号 Art.-No.	描述 Description	长度 Length
GD07GQ	宫颈钳 Cervical clamps	250mm

# Laparoscopy 胸腹外科

① 腹腔镜 Laparoscopy	32-33
② 腹腔镜手术器械 Laparoscopy instruments	34-39



腹腔镜 LAPAROSCOPE



型号 Art.-No.	视向角 Direction	外径 Outer	颜色代码 Color code
FQ0005330	0°	5mm	蓝 blue
FQ3005330	30°	5mm	红 red
FQ0010330	0°	10mm	蓝 blue
FQ3010330	30°	10mm	红 red

手术钳 SURGICAL INSTRUMENTS

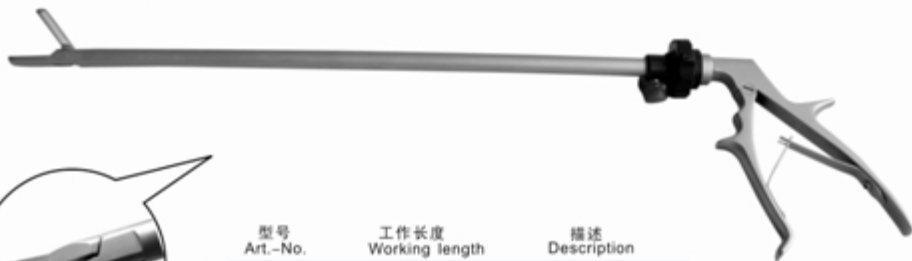

型号 Art.-No.	工作长度 Working length	描述 Description
FQ0001	330mm	10mm单动钛夹钳 10mmSingle clip applicator
FQ0002	330mm	10mm直角钛夹钳 10mmClip applicator
FQ0003	330mm	10mm双动钛夹钳 10mmDouble clip applicator
FQ0004	330mm	10mm深部钛夹钳 10mmClip applicator



型号 Art.-No.	工作长度 Working length	描述 Description
FQ0004	330mm	10mm取石钳 10mmBiopsy forceps
FQ0005	210mm	10mm取石钳 10mmBiopsy forceps

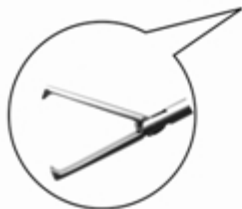

型号 Art.-No.	工作长度 Working length	描述 Description
FQ0006	330mm	10mm单开抓取钳 10mmClaw grasping forceps, single action
FQ0007	330mm	2.8mm单开抓取钳 2.8mmClaw grasping forceps, single action



泌尿外科  
Urology

耳鼻喉科  
E. N. T

妇科  
Gynecology

胸腹腔镜  
Thora-Laparoscopy

骨科  
Orthopaedics

附属设备  
Accessories



泌尿外科  
Urology

型号 Art.-No.	描述 Description
FQ0008	5.5mm穿刺套, 针 5.5mm Trocar sleeve and trocar



耳鼻喉科  
E.N.T

妇科  
Gynecology

型号 Art.-No.	描述 Description
FQ0009	10.5mm穿刺套, 针 10.5mm Trocar sleeve and trocar



胸腹外科  
Thora-Laparoscopy

型号 Art.-No.	描述 Description
FQ0010	10.5mm螺旋式穿刺套, 针 10.5mm Trocar sleeve and trocar



骨科  
Orthopaedics

型号 Art.-No.	描述 Description
FQ0011	10mm转5mm转换器 10mm to 5mm Reducer sleeve



附属设备  
Accessories

型号 Art.-No.	描述 Description
FQ0012	100mm气腹针 100mm Veress needle



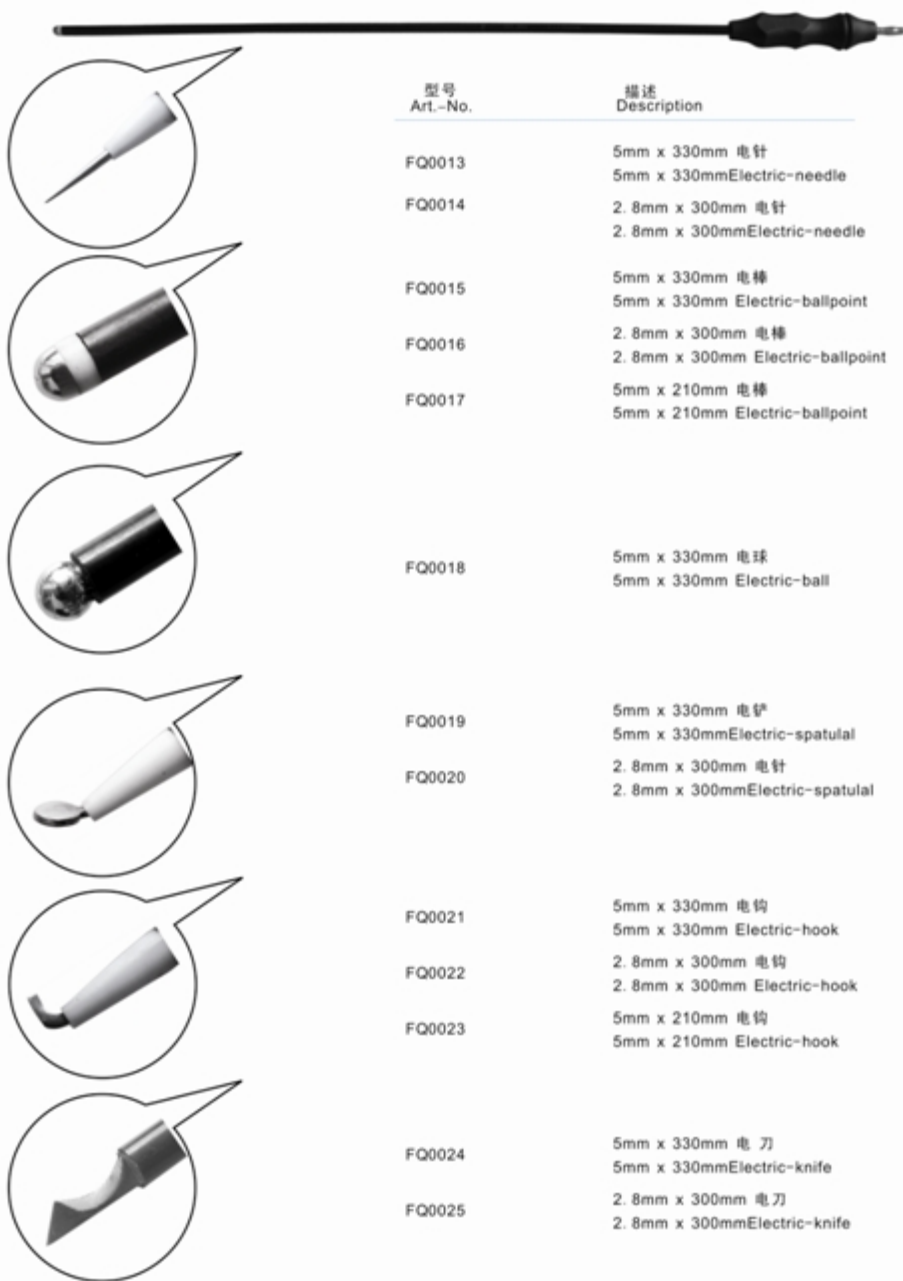

型号 Art.-No.	描述 Description
FQ0013	5mm x 330mm 电针 5mm x 330mm Electric-needle
FQ0014	2.8mm x 300mm 电针 2.8mm x 300mm Electric-needle
FQ0015	5mm x 330mm 电棒 5mm x 330mm Electric-ballpoint
FQ0016	2.8mm x 300mm 电棒 2.8mm x 300mm Electric-ballpoint
FQ0017	5mm x 210mm 电棒 5mm x 210mm Electric-ballpoint
FQ0018	5mm x 330mm 电球 5mm x 330mm Electric-ball
FQ0019	5mm x 330mm 电铲 5mm x 330mm Electric-spatula
FQ0020	2.8mm x 300mm 电针 2.8mm x 300mm Electric-spatula
FQ0021	5mm x 330mm 电钩 5mm x 330mm Electric-hook
FQ0022	2.8mm x 300mm 电钩 2.8mm x 300mm Electric-hook
FQ0023	5mm x 210mm 电钩 5mm x 210mm Electric-hook
FQ0024	5mm x 330mm 电刀 5mm x 330mm Electric-knife
FQ0025	2.8mm x 300mm 电刀 2.8mm x 300mm Electric-knife

泌尿外科  
Urology

耳鼻喉科  
E. N. T.

妇科  
Gynecology

胸腹腔镜  
Thora-Laparoscopy

骨科  
Orthopaedics

附属设备  
Accessories

泌尿外科  
Urology

V型持针钳 V-needle-holding-forceps



型号 Art.-No.	描述 Description
FQ00026	V型持针钳 V-needle-holding-forceps

耳鼻喉科  
E. N. T.

切开刀 Incision knife

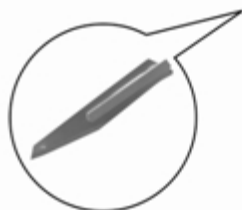

型号 Art.-No.	描述 Description
FQ00027	切开刀 Incision knife

妇科  
Gynecology

胸镜外科  
Thora-Laparoscopy

注射针 Incision knife



型号 Art.-No.	描述 Description
FQ00028	注射针 Incision knife

骨科  
Orthopaedics

冲洗器 Push type



型号 Art.-No.	描述 Description
FQ00029	5mm x 330mm
FQ00030	2.8mm x 300mm
FQ00031	10mm x 330mm
FQ00032	5mm x 210mm

附属设备  
Accessories

带电凝(钩)吸引器 Suction & Irrigation tube with electric-ballpoint(electric-hook)

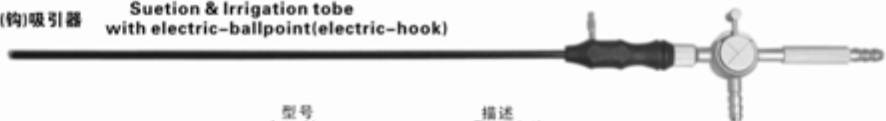

型号 Art.-No.	描述 Description
FQ00033	带电凝(钩)吸引器 Suction & Irrigation tube with electric-ballpoint (electric-hook)

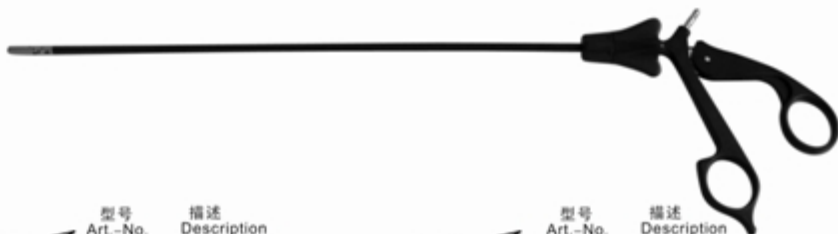

型号  
Art.-No. 描述  
Description

**弯分离钳**  
**Dissecting forceps(Curved)**  
FQ00034 10mm x 330mm  
FQ00035 5mm x 330mm  
FQ00036 2.8mm x 300mm  
FQ00037 5mm x 210mm



**小活检钳**  
**Small biopsy forceps**  
FQ00038 5mm x 330mm



**直角剥离钳**  
**Dissecting forceps(90 degree)**  
FQ00039 10mm x 330mm  
FQ00040 5mm x 330mm  
FQ00041 2.8mm x 300mm  
FQ00042 5mm x 210mm



**微型剪刀**  
**Tiny-scissors**  
FQ00043 5mm x 330mm



**粗齿钝头抓钳**  
**Blunt-nosed forceps**  
FQ00044 5mm x 330mm



**钝头抓钳**  
**Blunt-nosed forceps**  
FQ00045 5mm x 330mm  
FQ00046 2.8mm x 300mm



**中空锯齿抓钳**  
**Midheaven forceps(Vertical)**  
FQ00047 5mm x 330mm



型号  
Art.-No. 描述  
Description

**直剪刀**  
**Stright-scissors**  
FQ00048 10mm x 330mm  
FQ00049 5mm x 330mm  
FQ00050 2.8mm x 300mm  
FQ00051 5mm x 210mm



**鼠牙抓钳**  
**Set forceps**  
FQ00052 5mm x 330mm



**直剥离钳**  
**Dissecting forceps(Stright)**  
FQ00053 5mm x 330mm  
FQ00054 2.8mm x 300mm  
FQ00055 5mm x 210mm



**咬切钳**  
**Nip to cut forceps**  
FQ00056 5mm x 330mm



**O型抓钳(中空)**  
**O-forceps(Midheaven)**  
FQ00057 5mm x 330mm



**O型抓钳**  
**O-forceps**  
FQ00058 5mm x 330mm



**细齿抓钳**  
**Tongs type grab forceps**  
FQ00059 5mm x 330mm

泌尿外科  
Urology

耳鼻喉科  
E. N. T









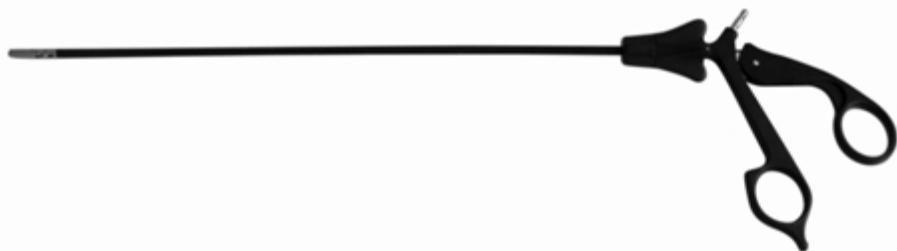



妇科  
Gynecology

胸腹腔镜  
Thora-Laparoscopy

骨科  
Orthopaedics

附属设备  
Accessories



型号 Art.-No.	描述 Description	型号 Art.-No.	描述 Description
 胆囊大抓钳	<b>Grasping forceps</b> FQ00060 10mm x 330mm	 犬齿活检钳	<b>Biopsy forceps(with eyetooth)</b> FQ00061 5mm x 330mm
 肝抓钳	<b>Liver grasping forceps</b> FQ00062 5mm x 330mm	 输卵管抓钳	<b>Oviduct forceps</b> FQ00071 5mm x 330mm
 长柄抓取钳	<b>Grasping forceps (large-jaw)</b> FQ00063 10mm x 330mm FQ00064 5mm x 330mm	 无损大抓钳	<b>Atraumatic forceps</b> FQ00072 10mm x 330mm
 钩型剪刀	<b>Curved-scissors</b> FQ00065 5mm x 330mm FQ00066 2.8mm x 300mm FQ00067 5mm x 210mm	 加长倒齿抓钳	<b>Pawl forceps(Lengthen)</b> FQ00073 5mm x 330mm
 长柄抓取钳(无齿)	<b>Grasping forceps (large-jaw/Midheaven)</b> FQ00068 5mm x 330mm	 B型打结钳(S型)	<b>B-knof forceps</b> FQ00074 5mm x 330mm
 尖头抓钳	<b>Tine forceps</b> FQ00069 2.8mm x 300mm FQ00070 5mm x 330mm	 吻合牵引钳	<b>Tally pull forceps</b> FQ00075 5mm x 330mm

**双极电凝钳 Double-electrode forceps**

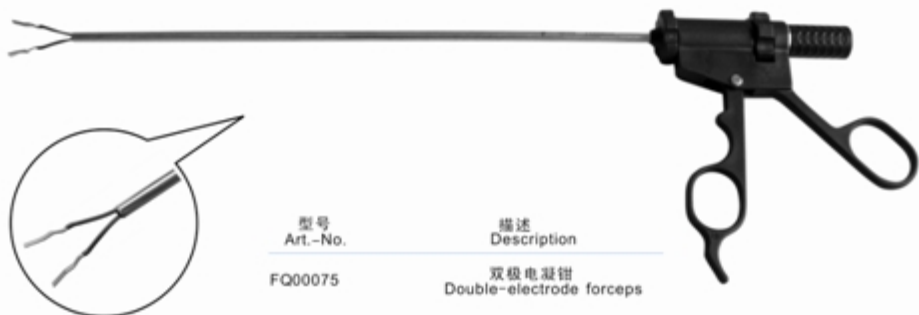

型号 Art.-No.	描述 Description
FQ00075	双极电凝钳 Double-electrode forceps



型号 Art.-No.	描述 Description
FQ00076	双极电凝线 Double-electrode wire



型号 Art.-No.	描述 Description
FQ00077	单极电凝线 Single-electrode wire

型号 Art.-No.	描述 Description
FQ00078	高频电刀 High frequency electric-cutter



型号 Art.-No.	描述 Description
FQ00079	20L/min Co <sub>2</sub> 气腹机 20L/min Insuffiator
FQ00080	30L/min Co <sub>2</sub> 气腹机 30L/min Insuffiator



泌尿外科  
Urology

耳鼻喉科  
E. N. T.

妇科  
Gynecology

腹腔镜外科  
Thora-Laparoscopy

骨科  
Orthopaedics

附属设备  
Accessories

## E. N. T 耳鼻喉科

<b>1</b> 鼻窦镜 .....	41
Sinoscope	
<b>2</b> 鼻窦镜手术器械 .....	42-47
Sinoscope instruments	
<b>3</b> 支撑喉镜 .....	48-51
Operating laryngoscope	
<b>4</b> 耳镜 .....	52
Otoscope	



### 4.0mm 鼻窥镜 4.0mm SINOSCOPE



型号 Art.-No.	视向角 Direction	工作长度 Working length	颜色代码 Color code
BD0004175	0° 	W/A	175mm 蓝 blue
	0° 		175mm 蓝 blue
BD3004175	30° 	W/A	175mm 红 red
	30° 		175mm 红 red
BD7004175	70° 	W/A	175mm 黄 yellow
	70° 		175mm 黄 yellow

“宽大视角”  
提供更大视野范围  
“Wide Angle” (W/A)  
Provide a bigger field of view

### 2.7mm 鼻窥镜 2.7mm SINOSCOPE



型号 Art.-No.	视向角 Direction	工作长度 Working length	颜色代码 Color code
BD0027175	0° 	175mm	蓝 blue
BD3027175	30° 	175mm	红 red

型号 Art.-No.	描述 Description
BD1001	斜型穿刺套 Cannula, oblique beak
BD1002	唇型穿刺套 Cannula, shaped beak

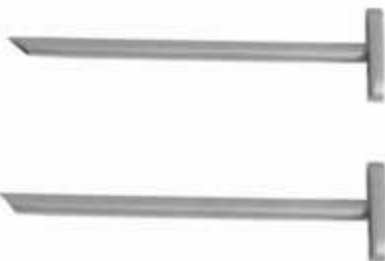



泌尿外科  
Urology

型号  
Art.-No.

描述  
Description

BD1003 穿刺针  
Trocar



耳鼻喉科  
E. N. T.

BD1004 双头剥离器  
Detacher, double heads



妇科  
Gynecology

BD1005 大号弯吸引管  
Suction tube, curved (large)

BD1006 小号弯吸引管  
Suction tube, curved (small)



胸腹外科  
Thora-Laparoscopy

BD1007 大号直吸引管  
Suction tube, straight (large)

BD1008 小号直吸引管  
Suction tube, straight (small)



骨科  
Orthopaedics



型号  
Art.-No.

描述  
Description

BD1009 正刮匙  
Antrum curette, forward

BD1010 反刮匙  
Antrum curette, background

附属设备  
Accessories



型号  
Art.-No.

描述  
Description

BD1011 尖头粘膜刀  
Sickle knife, pointed

BD1012 钝头粘膜刀  
Sickle knife, blunt



型号 Art.-No.	描述 Description
BD1013	直剪 Scissors, stright



型号 Art.-No.	描述 Description
BD1016	右剪 Scissors, right curved



型号 Art.-No.	描述 Description
BD1014	左剪 Scissors, left curved



型号 Art.-No.	描述 Description
BD1017	裂口异物钳 Alligator biopsy forceps



型号 Art.-No.	描述 Description
BD1015	反咬骨钳 Rongeur, backward



型号 Art.-No.	描述 Description
BD1018	正向咬骨钳 Rongeur, forward

泌尿外科  
Urology



型号 Art.-No.	描述 Description
BD1019	有孔直咬切钳 Cutting forceps with a hole, straight



型号 Art.-No.	描述 Description
BD1022	90° 咬切钳 90° Cutting forceps

耳鼻喉科  
E.N.T

妇科  
Gynecology

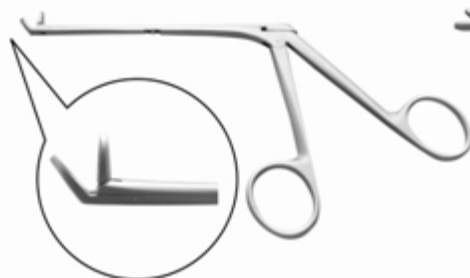

型号 Art.-No.	描述 Description
BD1020	45° 咬切钳 45° Cutting forceps



型号 Art.-No.	描述 Description
BD1023	0° 带吸引咬切钳 0° Cutting forceps, with suction tube

胸腹外科  
Thora-Laparoscopy

骨科  
Orthopaedics



型号 Art.-No.	描述 Description
BD1021	45° 带吸引咬切钳 45° Cutting forceps, with suction tube



型号 Art.-No.	描述 Description
BD1024	无孔直咬切钳 Cutting forceps, straight

附属设备  
Accessories



型号 Art.-No.	描述 Description
BD1025	70° 横开口息肉钳 70° Polyp forceps, Horizontal opening



型号 Art.-No.	描述 Description
BD1028	70° 直开口息肉钳 70° Polyp forceps, Vertical opening



型号 Art.-No.	描述 Description
BD1026	100° 直开口息肉钳 100° Polyp forceps, Vertical opening



型号 Art.-No.	描述 Description
BD1029	0° 直开口息肉钳 0° Polyp forceps, Vertical opening



型号 Art.-No.	描述 Description
BD1027	90° 无孔强力筛窦钳 90° Maxillary punch



型号 Art.-No.	描述 Description
BD1030	90° 有孔强力筛窦钳 90° Maxillary punch, with a hole



型号 Art.-No.	描述 Description
BD1031	0° 内窥镜 0° Optical forceps
BD1032	30° 内窥镜 30° Optical forceps
BD1033	70° 内窥镜 70° Optical forceps

型号 Art.-No.	描述 Description
BD1034	控制器 Control unit



技术参数：  
1 电源：AC110-220V, 50-60HZ；  
2. 输出功率≥50W；  
3调速，最高显示4000转/分；  
4开机自动记忆功能；  
5数字控制线路；  
6采用电源隔离装置，安全性高。

Technical data  
1. Power supply: AC110-220V, 50-60HZ;  
2. Output power ≥ 50W;  
3. Speed adjustable, highest speed is 4000/rm  
4. Automatic, memory function  
5. Digitally controlled circuit;  
6 Use power-isolation apparatus gets high safety

型号 Art.-No.	描述 Description
BD1035	全功能脚踏开关 Full-functional foot switch



整体铝合金制作，防水设计，  
可进行正转反转控制和往复转控制。

Complete aluminum made,  
water-proof Design, can be  
controlled to rotate in clockwise,  
anticlockwise and reciprocating  
direction.

手机马达 HANDLE MOTOR



采用瑞士进口电机和齿轮机构及德国进口连接器；直通式吸引通道，手术中畅通，清洗方便，全防水设计，可以进行浸泡消毒。刀具安装快捷方便，控制器刀头可以根据需要来安装，可选用直刀头及弯形刀。

Use Swiss imported motor and motor and gear structure and Germany imported connector, their aight suction channel makes the smooth suctioning surgery, easy to clean; full materproof design makes it soakable for sterilization. Blades are easy to install. Blades head direction of controller can be installed on request, can use either stright or curved blade.

型号 Art.-No.	描述 Description
BD1036	手机马达 Handle motor



平切刀

型号 Art.-No.	描述 Description
BD1037	Filer blade

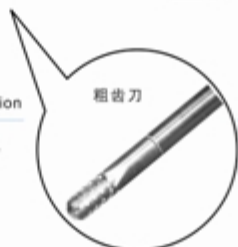

粗齿刀

型号 Art.-No.	描述 Description
BD1039	Toothed blade, thick



中齿刀

型号 Art.-No.	描述 Description
BD1038	Toothed blade, sharp

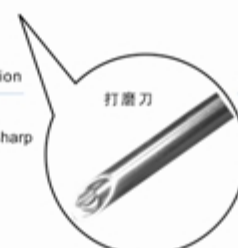

打磨刀

型号 Art.-No.	描述 Description
BD1040	Burr blade

泌尿外科  
Urology

耳鼻喉科  
E. N. T

妇科  
Gynecology

胸腹外科  
Thora-Laparoscopy

骨科  
Orthopaedics

附属设备  
Accessories

### 支撑喉镜配套 LARYNGOSCOPE USE WITH OPERATING LARYNGOSCOPE

型号 Art.-No.	描述 Description
ZH1001	大号喉镜 Microlaryngoscope handle, large
ZH1002	小号喉镜 Microlaryngoscope handle, small
ZH1003	支撑架 Operating laryngoscope holder
ZH1004	大号吸引管 suction tube, large
ZH1005	中号吸引管 suction tube, middle
ZH1006	小号吸引管 suction tube, small
ZH1204175	支撑喉镜 12' OPERATING LARYNGOSCOPE

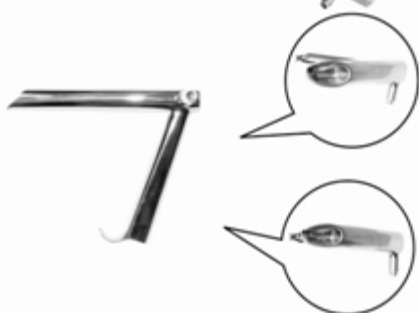



型号 Art.-No.	描述 Description
----------------	-------------------

ZH1017	手柄 Handle
--------	--------------



型号 Art.-No.	描述 Description
----------------	-------------------

ZH1018	喉刀 Laryngeal knife
--------	-----------------------

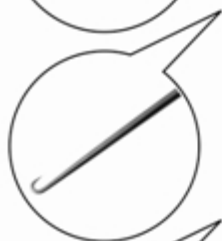

ZH1019	喉钩 Laryngeal hook
--------	----------------------



ZH1020	喉针 Laryngeal needle
--------	------------------------



泌尿外科  
Urology

耳鼻喉科  
E. N. T.

妇科  
Gynecology

胸腹外科  
Thora-Laparoscopy

骨科  
Orthopaedics

附属设备  
Accessories



型号  
Art.-No.

描述  
Description

ZH 1007 异物钳  
Foreign body forceps



ZH 1008 上弯三角型喉钳  
Cutting forceps curved upward



ZH 1009 直三角型喉钳  
Cutting forceps straight triangle



ZH 1010 上翘型喉剪  
Scissors, upward



ZH 1011 直形喉剪  
Scissors, straight



型号  
Art.-No.

描述  
Description

ZH 1012 碗口型喉钳  
Cutting forceps, round



ZH 1013 长圆口上翘型喉钳  
Round cup forceps, upward



ZH 1014 右开型喉钳  
Cutting forceps, curved right



ZH 1015 左开型喉钳  
Cutting forceps, curved left



ZH 1016 活检钳  
Biopsy forceps

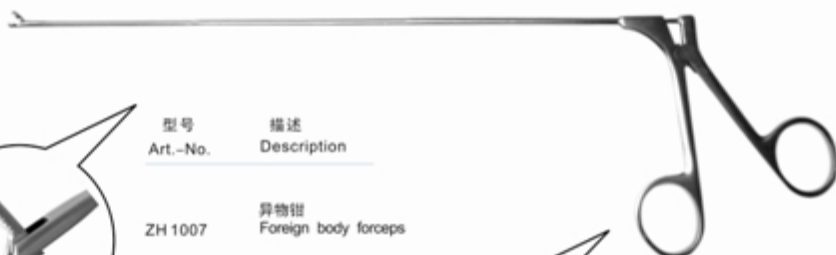

一柄三头喉钳



型号 Art.-No.	描述 Description
HO0001	活检头 Biopsy head
HO0002	直活检头 Straight biopsy head
HO0003	异物头 Foreign body head

喉镜 LARYNGOSCOPE



型号 Art.-No.	视角 Direction	工作长度 Working length	颜色代码 Color code	外径 Outer diameter
HO9008175	90°	175mm	蓝 blue	8mm
HO9010175	90°	175mm	蓝 blue	10mm

泌尿外科  
Urology

耳鼻喉科  
E.N.T.

妇科  
Gynecology

胸腹外科  
Thora-Laparoscopy

骨科  
Orthopaedics

附属设备  
Accessories

喉镜 LARYNGOSCOPE



型号 Art.-No.	视角 Direction	工作长度 Working length	颜色代码 Color code	外径 Outer diameter
HO7006175	70° 	175mm	黄 yellow	6mm
HO7008175	70° 	175mm	黄 yellow	8mm
HO7010175	70° 	175mm	黄 yellow	10mm

耳镜 OTOSCOPE



型号 Art.-No.	视角 Direction	工作长度 Working length	颜色代码 Color code	外径 Outer diameter
ER0004050	0° 	50mm	蓝 blue	4mm
ER3004050	30° 	50mm	红 red	4mm
ER0027060	0° 	60mm	蓝 blue	2.7mm
ER3027060	30° 	60mm	红 red	2.7mm

耳镜 OTOSCOPE



型号 Art.-No.	视角 Direction	工作长度 Working length	颜色代码 Color code	外径 Outer diameter
ER0027100	0° 	100mm	蓝 blue	2.7mm
ER3027100	30° 	100mm	红 red	2.7mm
ER0029100	0° 	100mm	蓝 blue	2.9mm
ER0033100	0° 	100mm	蓝 blue	3.3mm
ER3029100	30° 	100mm	红 red	2.9mm
ER3033100	30° 	100mm	红 red	3.3mm

Arthroscopy  
骨科

1	关节镜 Arthroscope	54-56
---	--------------------	-------

## 4.0mm 关节镜 4.0mm ARTHROSCOPE



型号 Art.-No.	视向角 Direction	工作长度 Working length	颜色代码 Color code
XG0004170	0° 	170mm	蓝 blue
	0°  W/A		
XG3004170	30° 	170mm	蓝 blue
	30°  W/A		
XG7004170	70° 	170mm	红 red
	70°  W/A		

“宽大视角”  
提供更大视野范围  
“Wide Angle”(W/A)  
Provide a bigger field of view

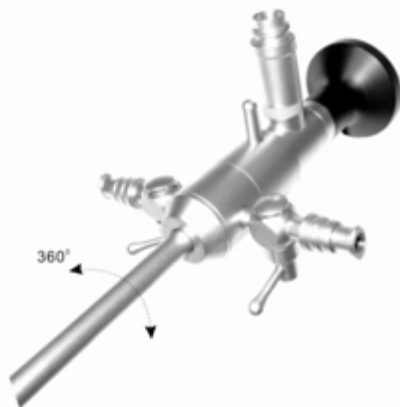

可360°旋转，可高温高压消毒不锈钢材质。

360° rotation high pressure and high temperature can be disinfected stainless steel material

4.0mm可旋转双阀镜鞘

4.0mm sheath with two stopcocks, rotatable

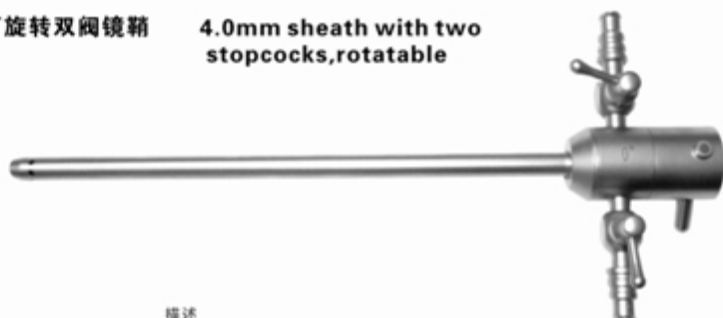

型号 Art.-No.	描述 Description
----------------	-------------------

XG01WQ	4.0mm可旋转双阀镜鞘 4.0mm sheath with two stopcocks, rotatable
--------	--

镜鞘闭孔器

Blunt obturator



型号 Art.-No.	描述 Description	型号 Art.-No.	描述 Description
XG01BK	镜鞘闭孔器 Blunt obturator	XG01CC	镜鞘穿刺器 Sharp obturator

泌尿外科  
Urology

耳鼻喉科  
E.N.T

妇科  
Gynecology

胸腹外科  
Thora-Laparoscopy

骨科  
Orthopaedics

附属设备  
Accessories

4.0mm可旋转双阀镜鞘

4.0mm sheath with two stopcocks, rotatable



型号 Art.-No.	描述 Description
XG02WQ	4.0mm可旋转双阀镜鞘 4.0mm sheath with two stopcocks, rotatable

镜鞘闭孔器

Blunt obturator



型号 Art.-No.	描述 Description	型号 Art.-No.	描述 Description
XG02BK	镜鞘闭孔器 Blunt obturator	XG02CC	镜鞘穿刺器 Sharp obturator



## Arthroscopy 附属设备

- |          |                                 |       |
|----------|---------------------------------|-------|
| <b>1</b> | 冷光源<br>Cold light source        | 58    |
| <b>2</b> | 摄像机<br>Video camera             | 58-60 |
| <b>3</b> | 导光束<br>Fiberoptic light cable   | 61    |
| <b>4</b> | 光学接口<br>Adapter (optic coupler) | 62-64 |
| <b>5</b> | 内窥镜软件<br>Software for endoscopy | 65    |



型号 Art.-No.	描述 Description
NT01	NT-300-1

输入电压: AC 100V-120V 或  
AC 200V-240V 50/60Hz  
 色温: 3600K  
 亮度调节: 自动  
 电源方式: 稳压开关电源  
 摄像机: NT-300型  
 功能: 自动白平衡, 冻结图像功能  
 输出: AV Yc端子  
 型号: NT-300-1型

VITILIZE: 250W double halogen lamp to the light source  
 INPUT VOLTAGE: AC 100V-120V or  
AC 200V-240V 50/60HZ  
 COLOR TEMPERATURE: 3600K  
 BRIGHTNESS ADJUSTMENT: adjustable, antrollable by panel  
 REGULATOR: SWITH POWER  
 CAMRA: NT-300  
 FUNCTION: Auto white balance  
 LIFE SPAN OF THE LAMP: above 50 hour



型号 Art.-No.	描述 Description
NT02	NT-300A

CCD 参数: 1/3CCD 480TV线 单晶片  
 照度: 0.8Lux F1.2  
 输出: AV Yc端子  
 输入电压: AC 100V-240V 50/60Hz  
 制式: PAL  
 功能: 自动白平衡  
CCD防水处理  
 型号: NT-300A型

CCD PARAMETER: 1/3&1/4 CCD 480&350TV lines  
 ILLUMINATCE: 0.8Lux F1.2  
 OUTPUT: AV YC  
 MODE: PAL  
 INPUT POWER: AC 100V-240V 50/60Hz  
 FUNCTION: 2 times enlarge, Auto white balance  
water-proof treatment on CCD  
 STYLE: NT-300 & NT-300A



型号 Art.-No.	描述 Description
BLG250	250W
BLG350	350W

灯泡参数: 250W 氙灯 单灯  
 输入电压: AC 100V-120V 或  
 AC 200V-240V 50/60Hz  
 色温: 5600K  
 亮度调节: 可调、面板触摸  
 电源方式: 稳压开关电源  
 灯泡寿命: 200小时以上

VITILIZE: 250W Xenon lamp to the light source  
 INPUT VOLTAGE: AC 100V-120V or  
 AC 200V-240V 50/60HZ  
 COLOR TEMPERATURE: 5600K  
 BRIGHTNESS ADJUSTMENT: adjustable, antrollable by panel  
 REGULATOR: SWITH POWER  
 LIFE SPAN OF THE LAMP: above 300 hour



型号 Art.-No.	描述 Description
BLG250	250W

灯泡参数: 250W 卤素灯 双灯  
 输入电压: AC 100V-120V 或  
 AC 200V-240V 50/60Hz  
 色温: 3600K  
 亮度调节: 可调、旋转调节  
 电源方式: 稳压开关电源

VITILIZE: 250W double halogen lamp to the light source  
 INPUT VOLTAGE: AC 100V-120V or  
 AC 200V-240V 50/60HZ  
 COLOR TEMPERATURE: 3600K  
 BRIGHTNESS ADJUSTMENT: adjustable, antrollable by panel  
 REGULATOR: SWITH POWER  
 LIFE SPAN OF THE LAMP: above 50 hour



泌尿外科  
Urology

型号 Art.-No.	描述 Description
NT03	NT-300

CCD 参数: 1/3CCD 480TV线 单晶片  
照 度: 0.8Lux F1.2  
输 出: AV Yc端子  
输入电压: AC 100V-240V 50/60Hz  
制 式: PAL  
功 能: 自动白平衡 CCD防水处理  
型 号: NT-300型  
调节方式: 面板调节 手柄调节

CCD PARAMETER: 1/3 CCD 480TV lines, 1-chip  
ILLUMINANCE: 0.8Lux F1.2  
OUTPUT: AV YC  
INPUT POWER: AC 100V-240V 50/60Hz  
MODE: PAL  
FUNCTION: 2 times enlarge. Handle white balance  
water-proof treatment on CCD  
STYLE: NT-300  
THE WAY OF ADJUSTMENT: adjust by panel  
adjust by handle



耳鼻喉科  
E.N.T

妇科  
Gynecology

胸腹外科  
Thora-Laparoscopy

型号 Art.-No.	描述 Description
NT04	1156

CCD 参数: 1/3CCD 1COLOR CCD  
750TV线 单晶片  
照 度: 3Lux F1.2  
输 出: YC端子, s-video  
输入电压: AC 100V-240V 50/60Hz  
制 式: PAL  
功 能: 逐行扫描摄像机采用全新的数字  
处理技术通过单个超高清晰度  
型 号: 1156型  
调节方式: 面板调节

CCD PARAMETER: 1/3CCD, 1 COLOR CCD;  
750 TV LINES, 1-CHIPS;  
ILLUMINANCE: 3 Lux F1.2  
OUTPUT: YC S-VIDEO  
INPUT POWER: AC 100V-240V, 50/60 Hz  
MODE: PAL or NTSC  
THE WAY OF ADJUSTMENT: Adjust by panel



骨科  
Orthopaedics

附属设备  
Accessories

泌尿外科  
Urology

耳鼻喉科  
E.N.T

妇科  
Gynecology

胸腹外科  
Thora-Laparoscopy

骨科  
Orthopaedics

附属设备  
Accessories

型号 Art.-No.	描述 Description
----------------	-------------------

NT05 3156

CCD 参数: 1/4CCD 3COLOR CCD  
800TV线 3晶片  
照 度: 3Lux F1.2  
输 出: S-VIDEO RGB YC端子  
输入电压: AC 100V-240V 50/60Hz  
制 式: PAL或NTSC  
功 能: 逐行扫描摄像机采用全新的数字  
处理技术通过单个超高清清晰度  
型 号: 3156型  
调节方式: 面板调节

CCD PARAMETER: 1/4 CCD, 3 COLOR CCD;  
800 TV LINES, 3-CHIPS;  
ILLUMINANCE: 3 Lux F1.2  
OUTPUT: YC S-VIDEO RGB  
INPUT POWER: AC 100V-240V, 50/60 Hz  
MODE: PAL or NTSC  
THE WAY of ADJUSTMENT: Adjust by panel



型号 Art.-No.	描述 Description
----------------	-------------------

JS14CS 14'  
JS15CS 15'  
JS17CS 17'

**彩色监视器**

型 号: 14寸 15寸 17寸  
功 能: 14寸不低于450线, 15寸17寸不低于750线  
色彩、亮度、对比度、  
锐度、可调, 成像清晰。

**COLORFUL MONITOR**  
color, bright, contrast ratio;  
acutance, adjustable, imaging clearly



型号 Art.-No.	描述 Description
JS18DD	1.5m
JS20DD	2.0m
JS25DD	2.5m

### 聚焦导光束(光镜)

型号: 1.8m 2.0m 2.5m  
 功能: 插入光源部分采用全新无透镜聚焦工艺, 无阴影, 透光量增加20%

### FOCUS GUIDE LIGHT CABLE

style: 1.8m 2.0m  
 fuction: the part of the inserted light source, utilize new, no-lens focus technology, no shadow, the amount of the passing light increase 20%

### 光源端型号

型号 Art.-No.	描述 Description
GL-P/STR	PENTAX转史赛克 The Pentax or stryker

型号 Art.-No.	描述 Description
GL-P/O	PENTAX转OLYMPUS The Pentax or olympus

型号 Art.-No.	描述 Description
GL-P/W	PENTAX转WOLF The Pentax or wolf

型号 Art.-No.	描述 Description
GL-O/W	OLYMPUS转WOLF The olympus or wolf

型号 Art.-No.	描述 Description
GL-P/S	PENTAX转STOTZ The pentax or stotz

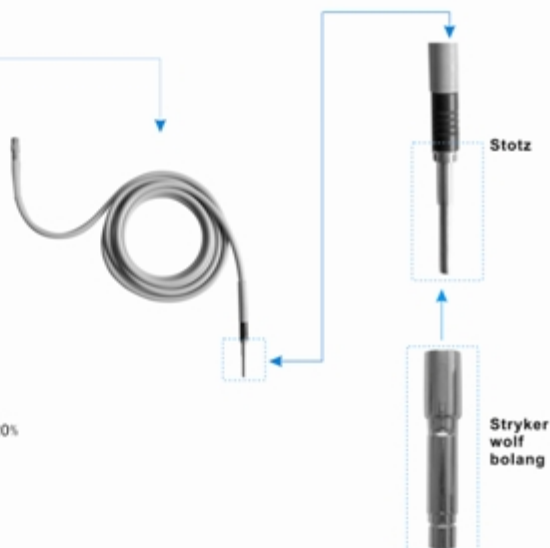

### 光学接口 ADAPTER(OPTIC COUPLER)

型号 Art.-No.	描述 Description
Y/O	硬型或OLYMPUS接口 The VIGID or OLYMPUS



泌尿外科  
Urology

耳鼻喉科  
E.N.T

型号 Art.-No.	描述 Description
O/P	OLYMPUS或PENTAX接口 The OLYMPUS or PENTAX



妇科  
Gynecology

型号 Art.-No.	描述 Description
P/O	PENTAX或OLYMPUS接口 The PENTAX or OLYMPUS



胸腹外科  
Thora-Laparoscopy

型号 Art.-No.	描述 Description
Y/P	硬型转PENTAX接口 The VIGID or PENTAX



骨科  
Orthopaedics

型号 Art.-No.	描述 Description
XZP	PENTAX直通接口 PENTAX Coupler in direct



型号 Art.-No.	描述 Description
YZC	硬锁直通接口 Couplev in direct for vigid



附属设备  
Accessories

### 光学接口 ADAPTER(OPTIC COUPLER)

型号 Art.-No.	描述 Description
KS-Y	硬镜直通接口 The DIVECT FOR OLYMPUS



型号 Art.-No.	描述 Description
KS-O	OLYMPUS纤维镜直通接口 The DIVECT FOR OLYMPUS FLEXIBLE



型号 Art.-No.	描述 Description
KS-P	PENTAX纤维镜直通接口 The DIVECT FOR PENTAX FLEXIBLE



型号 Art.-No.	描述 Description
P/Y	PENTAX转硬型接口 The Coupler reduled from PENTAX to vigid



型号 Art.-No.	描述 Description
O/Y	OLYMPUS转硬型接口 The DIVECT FOR PENTAX FLEXIBLE



**产品简介:**

内窥镜影像系统是现代医学重要的影像处理设备,采用主流高档PC计算机系统,结合高品质视频卡开发而成。软件采用数字化影像处理技术,帮助医生实现图文并茂的诊断报告,可与国内外各种型号的电子内窥镜、硬性内窥镜(腹腔镜、胸腔镜、膀胱镜、电子阴道镜、宫腔镜、耳鼻喉镜、关节镜等等)配合使用。数字化档案管理,是医院现代化资源管理的综合标志。

**功能:**

1. 快速高质量采集镜彩色图像;
2. 数字化大容量存储病例,任一病例无限采集存储图像;
3. 快捷、方便的病例查询、统计功能;
4. 具有图像后处理功能,可标注、注释等处理;
5. 具有可自由增加、修改的专家诊断词库;
6. 口令保护功能,严格保护病例数据,禁止未被授权的修改;
7. 资料可以刻录成光盘,保存更安全。

**特点:**

1. 熟悉的视窗平台,全图标操作;
2. 完善的提示机制和容错设计,确保用户的操作不致造成不可逆转的错误;
3. 数据库保存数据,避免图片等因单独存放而被误删的可能;
4. 解放医生双手,图像的冻结、激活和存储用脚踏控制。

**系统配置:**

1. 主流计算机(硬件根据市场流行情况配置);
2. 照片质量彩色喷墨打印机;
3. 高品质数字图像采集卡;
4. 图像采集脚踏开关;
5. 刻录机;
6. 手写输入识别系统(可选)。

**PRODUCT INTRODUCTION:**

Endoscope image displaying system is very important image-processing equipment in modern medical science. It utilizes high-grade mainstream PC computer systems, combining high-quality video card. The software uses digital be used with various electronic endoscopes, rigid endoscope, such as laparoscope, thoracoscope, cystoscope, electronic vaginoscope, hysteroscopy, ENT endoscope, arthroscopy and so on. The digital archive management is a comprehensive sign of the modern resource management in hospitals.

**FEATURES:**

1. With the familiar Windows platform, the entire icon operating;
2. The sound mechanism and fault-tolerant design, ensures that the users' operating can not cause any irreversible mistakes;
3. The data stores in the database, avoiding the pictures are cut by keeping separately;
4. Liberating hands of the doctors, frozen, activate and store the image by their feet control.

型号 Art.-No.	描述 Description
YX01GZ	台式机
YX02GZ	笔记本



**FUNCTION:**

1. Fast and high-quality collect real color image;
2. Digital, large-capacity store case history, no limited collect, store image in single case;
3. The fast and convenient case inquiring, and statistical functions;
4. With the image post-processing function, can tag and note;
5. Free to increase, modify the experts' diagnosis thesaurus;
6. The function of password protection, can protect the data of the medical case strictly, prohibit the no-authorized modification;
7. The data can be recorded into the CD, then the preservation can be more secure.

**SYSTEM SETTINGS:**

1. Mainstream computer (hardware configure based on market prevalence);
2. high-quality photos by color inkjet printers;
3. high-quality digital image acquisition card;
4. image acquisition pedal switch;
5. Recorder;
6. Hand-writing inputting recognition system(optional).

泌尿外科  
Urology

耳鼻喉科  
E.N.T

妇科  
Gynecology

腹腔镜  
Thura-Laparoscopy

骨科  
Orthopaedics

附属设备  
Accessories





[www.bolang-tech.com](http://www.bolang-tech.com)

**天津博朗科技发展有限公司**

TIANJIN BOLANG SCIENCE-TECHNOLOGY DEVELOPMENT CO.,LTD

地址:天津海泰绿色产业基地二纬路6号D座401室

D-401 No.6Erwei Road,Haitai Green Industrial Base Tianjin

Tel:0086-022-2378 8273

Fax:0086-022-2378 8271

Email:[bolang@vip.163.com](mailto:bolang@vip.163.com)